

# LM2940/LM2940C

## 1A Low Dropout Regulator

### General Description

The LM2940/LM2940C positive voltage regulator features the ability to source 1A of output current with a dropout voltage of typically 0.5V and a maximum of 1V over the entire temperature range. Furthermore, a quiescent current reduction circuit has been included which reduces the ground current when the differential between the input voltage and the output voltage exceeds approximately 3V. The quiescent current with 1A of output current and an input-output differential of 5V is therefore only 30 mA. Higher quiescent currents only exist when the regulator is in the dropout mode ( $V_{IN} - V_{OUT} \leq 3V$ ).

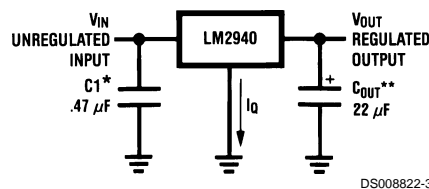
Designed also for vehicular applications, the LM2940/LM2940C and all regulated circuitry are protected from reverse battery installations or 2-battery jumps. During line transients, such as load dump when the input voltage can

momentarily exceed the specified maximum operating voltage, the regulator will automatically shut down to protect both the internal circuits and the load. The LM2940/LM2940C cannot be harmed by temporary mirror-image insertion. Familiar regulator features such as short circuit and thermal overload protection are also provided.

### Features

- Dropout voltage typically 0.5V @  $I_O = 1A$
- Output current in excess of 1A
- Output voltage trimmed before assembly
- Reverse battery protection
- Internal short circuit current limit
- Mirror image insertion protection
- P+ Product Enhancement tested

### Typical Application



\*Required if regulator is located far from power supply filter.

\*\* $C_{OUT}$  must be at least 22  $\mu F$  to maintain stability. May be increased without bound to maintain regulation during transients. Locate as close as possible to the regulator. This capacitor must be rated over the same operating temperature range as the regulator and the ESR is critical; see curve.

### Ordering Information

| Temperature Range                       | Output Voltage               |                            |                              |                          |                            |                            | Package                  |
|---|------------------------------|----------------------------|------------------------------|--------------------------|----------------------------|----------------------------|--------------------------|
|   | 5.0                          | 8.0                        | 9.0                          | 10                       | 12                         | 15                         |                          |
| $0^\circ C \leq T_J \leq 125^\circ C$   | LM2940CT-5.0<br>LM2940CS-5.0 |                            | LM2940CT-9.0<br>LM2940CS-9.0 |                          | LM2940CT-12<br>LM2940CS-12 | LM2940CT-15<br>LM2940CS-15 | TO-220<br>TO-263         |
| $-40^\circ C \leq T_J \leq 125^\circ C$ | LM2940T-5.0<br>LM2940S-5.0   | LM2940T-8.0<br>LM2940S-8.0 | LM2940T-9.0<br>LM2940S-9.0   | LM2940T-10<br>LM2940S-10 | LM2940T-12<br>LM2940S-12   |                            | TO-220<br>TO-263         |
| $-40^\circ C \leq T_J \leq 85^\circ C$  | LM2940IMP-5.0                | LM2940IMP-8.0              | LM2940IMP-9.0                | LM2940IMP-10             | LM2940IMP-12               | LM2940IMP-15               | SOT-223                  |
|   | LM2940IMPX-5.0               | LM2940IMPX-8.0             | LM2940IMPX-9.0               | LM2940IMPX-10            | LM2940IMPX-12              | LM2940IMPX-15              | SOT-223 in Tape and Reel |
| SOT-223 Package Marking                 | L53B                         | L54B                       | L0EB                         | L55B                     | L56B                       | L70B                       |                          |

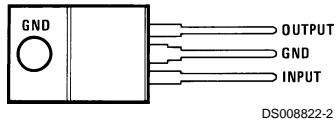
The physical size of the SOT-223 is too small to contain the full device part number. The package markings indicated are what will appear on the actual device.

| Temperature Range                       | Output Voltage                    |                                    |                                   |                                   | Package |
|---|-----------------------------------|------------------------------------|-----------------------------------|-----------------------------------|---------|
|   | 5.0                               | 8.0                                | 12                                | 15                                |         |
| $-55^\circ C \leq T_J \leq 125^\circ C$ | LM2940J-5.0/883<br>5962-8958701EA | LM2940J-8.0/883<br>5962-9088301QEA | LM2940J-12/883<br>5962-9088401QEA | LM2940J-15/883<br>5962-9088501QEA | J16A    |
|   | LM2940WG5.0/883<br>5962-8958701XA |                                    |                                   |                                   | WG16A   |

For information on military temperature range products, please go to the Mil/Aero Web Site at <http://www.national.com/appinfo/milaero/index.html>.

## Connection Diagrams

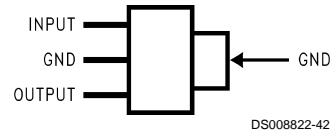
(TO-220) Plastic Package



Front View

Order Number LM2940CT-5.0, LM2940CT-9.0,  
LM2940CT-12, LM2940CT-15, LM2940T-5.0,  
LM2940T-8.0, LM2940T-9.0,  
LM2940T-10 or LM2940T-12  
See NS Package Number TO3B

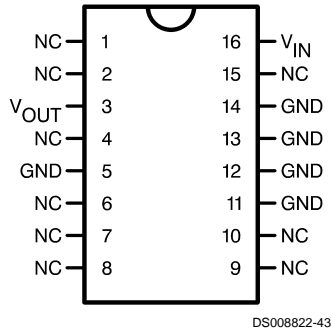
3-Lead SOT-223



Front View

Order Part Number LM2940IMP-5.0,  
LM2940IMP-8.0, LM2940IMP-9.0,  
LM2940IMP-10, LM2940IMP-12 or LM2940IMP-15  
See NS Package Number MP04A

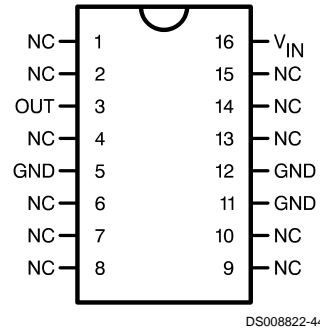
16-Lead Dual-in-Line Package (J)



Top View

Order Number LM2940J-5.0/883 (5962-8958701EA),  
LM2940J-8.0/883 (5962-9088301QEA),  
LM2940J-12/883 (5962-9088401QEA),  
LM2940J-15/883 (5962-9088501QEA)  
See NS Package Number J16A

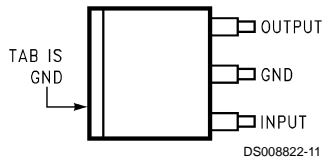
16-Lead Ceramic Surface-Mount Package (WG)



Top View

Order Number LM2940WG5.0/883 (5962-8958701XA)  
See NS Package Number WG16A

(TO-263) Surface-Mount Package



Top View



Side View

Order Number LM2940CS-5.0, LM2940CS-9.0,  
LM2940CS-12, LM2940CS-15,  
LM2940S-5.0, LM2940S-8.0,  
LM2940S-9.0, LM2940S-10 or LM2940S-12  
See NS Package Number TS3B

**Absolute Maximum Ratings** (Note 1)

If Military/Aerospace specified devices are required, please contact the National Semiconductor Sales Office/Distributors for availability and specifications.

|   |  |
|---|--|
| LM2940S, T, MP $\leq$ 100 ms                                    | 60V  |
| LM2940CS, T $\leq$ 1 ms   | 45V  |
| Internal Power Dissipation<br>(Note 2)                          | Internally Limited                                       |
| Maximum Junction Temperature                                    | 150°C  |
| Storage Temperature Range                                       | $-65^{\circ}\text{C} \leq T_J \leq +150^{\circ}\text{C}$ |
| Lead Temperature, Time for Wave Soldering<br>TO-220 (T) Package | 260°C, 10s   |

|                             |           |
|-----------------------------|-----------|
| TO-263 (S) Package          | 260°C, 4s |
| SOT-223 (MP) Package        | 260°C, 4s |
| ESD Susceptibility (Note 3) | 2 kV      |

**Operating Conditions** (Note 1)

|                    |   |
|--------------------|---|
| Input Voltage      | 26V   |
| Temperature Range  |   |
| LM2940T, LM2940S   | $-40^{\circ}\text{C} \leq T_J \leq 125^{\circ}\text{C}$ |
| LM2940CT, LM2940CS | $0^{\circ}\text{C} \leq T_J \leq 125^{\circ}\text{C}$   |
| LM2940IMP          | $-40^{\circ}\text{C} \leq T_J \leq 85^{\circ}\text{C}$  |
| LM2940J, LM2940WG  | $-55^{\circ}\text{C} \leq T_J \leq 125^{\circ}\text{C}$ |

**Electrical Characteristics**

$V_{IN} = V_O + 5V$ ,  $I_O = 1A$ ,  $C_O = 22 \mu F$ , unless otherwise specified. **Boldface limits apply over the entire operating temperature range of the indicated device.** All other specifications apply for  $T_A = T_J = 25^{\circ}\text{C}$ .

| Output Voltage ( $V_O$ ) |  | 5V   |  |                                 | 8V   |   |                                 | Units                   |
|--------------------------|--|------|--|---------------------------------|------|---|---------------------------------|-------------------------|
| Parameter                | Conditions   | Typ  | LM2940<br>Limit<br>(Note 4)                    | LM2940/883<br>Limit<br>(Note 5) | Typ  | LM2940<br>Limit<br>(Note 4)                   | LM2940/883<br>Limit<br>(Note 5) |                         |
| Output Voltage           | $5 \text{ mA} \leq I_O \leq 1A$  | 5.00 | <b><math>6.25V \leq V_{IN} \leq 26V</math></b> |                                 | 8.00 | <b><math>9.4V \leq V_{IN} \leq 26V</math></b> |                                 | $V_{MIN}$<br>$V_{MAX}$  |
|                          |  |      | 4.85/ <b>4.75</b>                              | 4.85/ <b>4.75</b>               |      | 7.76/ <b>7.60</b>                             | 7.76/ <b>7.60</b>               |                         |
| Line Regulation          | $V_O + 2V \leq V_{IN} \leq 26V$ ,<br>$I_O = 5 \text{ mA}$                                  | 20   | 50   | 40/ <b>50</b>                   | 20   | 80  | 50/ <b>80</b>                   | $\text{mV}_{MAX}$       |
| Load Regulation          | $50 \text{ mA} \leq I_O \leq 1A$<br>LM2940, LM2940/883<br>LM2940C                          | 35   | 50/ <b>80</b>                                  | 50/ <b>100</b>                  | 55   | 80/ <b>130</b>                                | 80/ <b>130</b>                  | $\text{mV}_{MAX}$       |
|                          |  | 35   | 50   |                                 | 55   | 80  |                                 |                         |
| Output Impedance         | 100 mADC and<br>20 mArms,<br>$f_O = 120 \text{ Hz}$  | 35   |  | 1000/ <b>1000</b>               | 55   |   | 1000/ <b>1000</b>               | $\text{m}\Omega$        |
| Quiescent Current        | $V_O + 2V \leq V_{IN} \leq 26V$ ,<br>$I_O = 5 \text{ mA}$<br>LM2940, LM2940/883<br>LM2940C | 10   | 15/ <b>20</b>                                  | 15/ <b>20</b>                   | 10   | 15/ <b>20</b>                                 | 15/ <b>20</b>                   | $\text{mA}_{MAX}$       |
|                          |  | 10   | 15   |                                 | 10   | 15  |                                 |                         |
|                          | $V_{IN} = V_O + 5V$ ,<br>$I_O = 1A$  | 30   | 45/ <b>60</b>                                  | 50/ <b>60</b>                   | 30   | 45/ <b>60</b>                                 | 50/ <b>60</b>                   | $\text{mA}_{MAX}$       |
| Output Noise Voltage     | 10 Hz – 100 kHz,<br>$I_O = 5 \text{ mA}$   | 150  |  | 700/ <b>700</b>                 | 240  |   | 1000/ <b>1000</b>               | $\mu\text{V}_{rms}$     |
| Ripple Rejection         | $f_O = 120 \text{ Hz}$ , $1 V_{rms}$ ,<br>$I_O = 100 \text{ mA}$<br>LM2940<br>LM2940C      | 72   | 60/ <b>54</b>                                  |                                 | 66   | 54/ <b>48</b>                                 |                                 | $\text{dB}_{MIN}$       |
|                          |  | 72   | 60   |                                 | 66   | 54  |                                 |                         |
|                          | $f_O = 1 \text{ kHz}$ , $1 V_{rms}$ ,<br>$I_O = 5 \text{ mA}$                              |      |  | 60/ <b>50</b>                   |      |   | 54/ <b>48</b>                   | $\text{dB}_{MIN}$       |
| Long Term Stability      |  | 20   |  |                                 | 32   |   |                                 | $\text{mV}/$<br>1000 Hr |
| Dropout Voltage          | $I_O = 1A$   | 0.5  | 0.8/ <b>1.0</b>                                | 0.7/ <b>1.0</b>                 | 0.5  | 0.8/ <b>1.0</b>                               | 0.7/ <b>1.0</b>                 | $V_{MAX}$               |
|                          | $I_O = 100 \text{ mA}$   | 110  | 150/ <b>200</b>                                | 150/ <b>200</b>                 | 110  | 150/ <b>200</b>                               | 150/ <b>200</b>                 | $\text{mV}_{MAX}$       |
| Short Circuit Current    | (Note 6)   | 1.9  | 1.6  | 1.5/ <b>1.3</b>                 | 1.9  | 1.6   | 1.6/ <b>1.3</b>                 | $A_{MIN}$               |

## Electrical Characteristics (Continued)

$V_{IN} = V_O + 5V$ ,  $I_O = 1A$ ,  $C_O = 22 \mu F$ , unless otherwise specified. **Boldface limits apply over the entire operating temperature range of the indicated device.** All other specifications apply for  $T_A = T_J = 25^\circ C$ .

| Output Voltage ( $V_O$ )                       |  | 5V         |                             |                                 | 8V         |                             |                                 | Units     |
|--|--|------------|-----------------------------|---------------------------------|------------|-----------------------------|---------------------------------|-----------|
| Parameter                                      | Conditions   | Typ        | LM2940<br>Limit<br>(Note 4) | LM2940/883<br>Limit<br>(Note 5) | Typ        | LM2940<br>Limit<br>(Note 4) | LM2940/883<br>Limit<br>(Note 5) |           |
| Maximum Line<br>Transient                      | $R_O = 100\Omega$                                    |            |                             |                                 |            |                             |                                 | $V_{MIN}$ |
|  | LM2940, $T \leq 100$ ms                              | 75         | <b>60/60</b>                |                                 | 75         | <b>60/60</b>                |                                 |           |
|  | LM2940/883, $T \leq 20$ ms<br>LM2940C, $T \leq 1$ ms | 55         | 45                          | <b>40/40</b>                    | 55         | 45                          | <b>40/40</b>                    |           |
| Reverse Polarity<br>DC Input Voltage           | $R_O = 100\Omega$                                    |            |                             |                                 |            |                             |                                 | $V_{MIN}$ |
|  | LM2940, LM2940/883<br>LM2940C                        | -30<br>-30 | <b>-15/-15</b><br>-15       | <b>-15/-15</b>                  | -30<br>-30 | <b>-15/-15</b><br>-15       | <b>-15/-15</b>                  |           |
| Reverse Polarity<br>Transient Input<br>Voltage | $R_O = 100\Omega$                                    |            |                             |                                 |            |                             |                                 | $V_{MIN}$ |
|  | LM2940, $T \leq 100$ ms                              | -75        | <b>-50/-50</b>              |                                 | -75        | <b>-50/-50</b>              |                                 |           |
|  | LM2940/883, $T \leq 20$ ms<br>LM2940C, $T \leq 1$ ms | -55        | <b>-45/-45</b>              | <b>-45/-45</b>                  |            |                             | <b>-45/-45</b>                  |           |

## Electrical Characteristics

$V_{IN} = V_O + 5V$ ,  $I_O = 1A$ ,  $C_O = 22 \mu F$ , unless otherwise specified. **Boldface limits apply over the entire operating temperature range of the indicated device.** All other specifications apply for  $T_A = T_J = 25^\circ C$ .

| Output Voltage ( $V_O$ ) |   | 9V   |                                      | 10V  |  | Units                  |
|--------------------------|---|--|--------------------------------------|--|--|------------------------|
| Parameter                | Conditions  | Typ  | LM2940<br>Limit<br>(Note 4)          | Typ  | LM2940<br>Limit<br>(Note 4)            |                        |
| Output Voltage           | $5 \text{ mA} \leq I_O \leq 1A$   | <b><math>10.5V \leq V_{IN} \leq 26V</math></b> |                                      | <b><math>11.5V \leq V_{IN} \leq 26V</math></b> |  | $V_{MIN}$<br>$V_{MAX}$ |
|                          |   | 9.00   | <b>8.73/8.55</b><br><b>9.27/9.45</b> | 10.00  | <b>9.70/9.50</b><br><b>10.30/10.50</b> |                        |
| Line Regulation          | $V_O + 2V \leq V_{IN} \leq 26V$ ,<br>$I_O = 5 \text{ mA}$                             | 20   | 90                                   | 20   | 100                                    | $mV_{MAX}$             |
| Load Regulation          | $50 \text{ mA} \leq I_O \leq 1A$<br>LM2940<br>LM2940C                                 | 60   | <b>90/150</b>                        | 65   | <b>100/165</b>                         | $mV_{MAX}$             |
|                          |   | 60   | 90                                   |  |  |                        |
| Output Impedance         | 100 mADC and<br>20 mArms,<br>$f_O = 120 \text{ Hz}$                                   | 60   |                                      | 65   |  | $m\Omega$              |
| Quiescent<br>Current     | $V_O + 2V \leq V_{IN} < 26V$ ,<br>$I_O = 5 \text{ mA}$<br>LM2940<br>LM2940C           | 10   | <b>15/20</b>                         | 10   | <b>15/20</b>                           | $mA_{MAX}$             |
|                          |   | 10   | 15                                   |  |  |                        |
|                          |   | $V_{IN} = V_O + 5V$ , $I_O = 1A$               | 30                                   | <b>45/60</b>                                   | 30                                     | <b>45/60</b>           |
| Output Noise<br>Voltage  | 10 Hz – 100 kHz,<br>$I_O = 5 \text{ mA}$  | 270  |                                      | 300  |  | $\mu V_{rms}$          |
| Ripple Rejection         | $f_O = 120 \text{ Hz}$ , $1 V_{rms}$ ,<br>$I_O = 100 \text{ mA}$<br>LM2940<br>LM2940C | 64   | <b>52/46</b>                         | 63   | <b>51/45</b>                           | $dB_{MIN}$             |
|                          |   | 64   | 52                                   |  |  |                        |
| Long Term<br>Stability   |   | 34   |                                      | 36   |  | $mV/$<br>1000 Hr       |
| Dropout Voltage          | $I_O = 1A$  | 0.5  | <b>0.8/1.0</b>                       | 0.5  | <b>0.8/1.0</b>                         | $V_{MAX}$              |
|                          | $I_O = 100 \text{ mA}$  | 110  | <b>150/200</b>                       | 110  | <b>150/200</b>                         | $mV_{MAX}$             |

## Electrical Characteristics (Continued)

$V_{IN} = V_O + 5V$ ,  $I_O = 1A$ ,  $C_O = 22 \mu F$ , unless otherwise specified. **Boldface limits apply over the entire operating temperature range of the indicated device.** All other specifications apply for  $T_A = T_J = 25^\circ C$ .

| Output Voltage ( $V_O$ )                 |   | 9V         |                                  | 10V |                             | Units     |
|--|---|------------|----------------------------------|-----|-----------------------------|-----------|
| Parameter                                | Conditions  | Typ        | LM2940<br>Limit<br>(Note 4)      | Typ | LM2940<br>Limit<br>(Note 4) |           |
| Short Circuit Current                    | (Note 6)  | 1.9        | 1.6                              | 1.9 | 1.6                         | $A_{MIN}$ |
| Maximum Line Transient                   | $R_O = 100\Omega$<br>$T \leq 100 \text{ ms}$<br>LM2940<br>LM2940C | 75<br>55   | <b>60/60</b><br>45               | 75  | <b>60/60</b>                | $V_{MIN}$ |
| Reverse Polarity DC Input Voltage        | $R_O = 100\Omega$<br>LM2940<br>LM2940C                            | -30<br>-30 | <b>-15/-15</b><br>-15            | -30 | <b>-15/-15</b>              | $V_{MIN}$ |
| Reverse Polarity Transient Input Voltage | $R_O = 100\Omega$<br>$T \leq 100 \text{ ms}$<br>LM2940<br>LM2940C | -75<br>-55 | <b>-50/-50</b><br><b>-45/-45</b> | -75 | <b>-50/-50</b>              | $V_{MIN}$ |

## Electrical Characteristics

$V_{IN} = V_O + 5V$ ,  $I_O = 1A$ ,  $C_O = 22 \mu F$ , unless otherwise specified. **Boldface limits apply over the entire operating temperature range of the indicated device.** All other specifications apply for  $T_A = T_J = 25^\circ C$ .

| Output Voltage ( $V_O$ ) |  | 12V  |  |  | 15V   |  |  | Units         |
|--------------------------|--|--|--|--|---|--|--|---------------|
| Parameter                | Conditions   | Typ  | LM2940<br>Limit<br>(Note 4)              | LM2940/833<br>Limit<br>(Note 5)          | Typ   | LM2940<br>Limit<br>(Note 4)              | LM2940/833<br>Limit<br>(Note 5)          |               |
| Output Voltage           | $5 \text{ mA} \leq I_O \leq 1A$  | <b><math>13.6V \leq V_{IN} \leq 26V</math></b> |  |  | <b><math>16.75V \leq V_{IN} \leq 26V</math></b> |  |  | $V_{MIN}$     |
|                          |  | 12.00  | <b>11.64/11.40</b><br><b>12.36/12.60</b> | <b>11.64/11.40</b><br><b>12.36/12.60</b> | 15.00   | <b>14.55/14.25</b><br><b>15.45/15.75</b> | <b>14.55/14.25</b><br><b>15.45/15.75</b> | $V_{MAX}$     |
| Line Regulation          | $V_O + 2V \leq V_{IN} \leq 26V$ ,<br>$I_O = 5 \text{ mA}$                                  | 20   | 120                                      | <b>75/120</b>                            | 20  | 150                                      | <b>95/150</b>                            | $mV_{MAX}$    |
| Load Regulation          | $50 \text{ mA} \leq I_O \leq 1A$<br>LM2940, LM2940/883<br>LM2940C                          | 55   | <b>120/200</b>                           | <b>120/190</b>                           |   |  | <b>150/240</b>                           | $mV_{MAX}$    |
|                          |  | 55   | 120                                      |  | 70  | 150                                      |  |               |
| Output Impedance         | 100 mADC and<br>20 mArms,<br>$f_O = 120 \text{ Hz}$  | 80   |  | <b>1000/1000</b>                         | 100   |  | <b>1000/1000</b>                         | $m\Omega$     |
| Quiescent Current        | $V_O + 2V \leq V_{IN} \leq 26V$ ,<br>$I_O = 5 \text{ mA}$<br>LM2940, LM2940/883<br>LM2940C | 10   | <b>15/20</b>                             | <b>15/20</b>                             |   |  | <b>15/20</b>                             | $mA_{MAX}$    |
|                          |  | 10   | 15                                       |  | 10  | 15                                       |  |               |
|                          | $V_{IN} = V_O + 5V$ , $I_O = 1A$   | 30   | <b>45/60</b>                             | <b>50/60</b>                             | 30  | <b>45/60</b>                             | <b>50/60</b>                             | $mA_{MAX}$    |
| Output Noise Voltage     | 10 Hz – 100 kHz,<br>$I_O = 5 \text{ mA}$   | 360  |  | <b>1000/1000</b>                         | 450   |  | <b>1000/1000</b>                         | $\mu V_{rms}$ |
| Ripple Rejection         | $f_O = 120 \text{ Hz}$ , $1 V_{rms}$ ,<br>$I_O = 100 \text{ mA}$<br>LM2940<br>LM2940C      | 66   | <b>54/48</b>                             |  |   |  |  | $dB_{MIN}$    |
|                          |  | 66   | 54                                       |  | 64  | 52                                       |  |               |
|                          | $f_O = 1 \text{ kHz}$ , $1 V_{rms}$ ,<br>$I_O = 5 \text{ mA}$                              |  |  | <b>52/46</b>                             |   |  | <b>48/42</b>                             | $dB_{MIN}$    |

## Electrical Characteristics (Continued)

$V_{IN} = V_O + 5V$ ,  $I_O = 1A$ ,  $C_O = 22 \mu F$ , unless otherwise specified. **Boldface limits apply over the entire operating temperature range of the indicated device.** All other specifications apply for  $T_A = T_J = 25^\circ C$ .

| Output Voltage ( $V_O$ )                 |                                    | 12V |                             |                                 | 15V |                             |                                 | Units          |
|--|------------------------------------|-----|-----------------------------|---------------------------------|-----|-----------------------------|---------------------------------|----------------|
| Parameter                                | Conditions                         | Typ | LM2940<br>Limit<br>(Note 4) | LM2940/833<br>Limit<br>(Note 5) | Typ | LM2940<br>Limit<br>(Note 4) | LM2940/833<br>Limit<br>(Note 5) |                |
| Long Term Stability                      |                                    | 48  |                             |                                 | 60  |                             |                                 | mV/<br>1000 Hr |
| Dropout Voltage                          | $I_O = 1A$                         | 0.5 | 0.8/ <b>1.0</b>             | 0.7/ <b>1.0</b>                 | 0.5 | 0.8/ <b>1.0</b>             | 0.7/ <b>1.0</b>                 | $V_{MAX}$      |
|  | $I_O = 100 \text{ mA}$             | 110 | 150/ <b>200</b>             | 150/ <b>200</b>                 | 110 | 150/ <b>200</b>             | 150/ <b>200</b>                 | $mV_{MAX}$     |
| Short Circuit Current                    | (Note 6)                           | 1.9 | 1.6                         | 1.6/ <b>1.3</b>                 | 1.9 | 1.6                         | 1.6/ <b>1.3</b>                 | $A_{MIN}$      |
| Maximum Line Transient                   | $R_O = 100\Omega$                  |     |                             |                                 |     |                             |                                 |                |
|  | LM2940, $T \leq 100 \text{ ms}$    | 75  | 60/ <b>60</b>               |                                 |     |                             |                                 | $V_{MIN}$      |
|  | LM2940/883, $T \leq 20 \text{ ms}$ |     |                             | 40/ <b>40</b>                   |     |                             | 40/ <b>40</b>                   |                |
|  | LM2940C, $T \leq 1 \text{ ms}$     | 55  | 45                          |                                 | 55  | 45                          |                                 |                |
| Reverse Polarity DC Input Voltage        | $R_O = 100\Omega$                  |     |                             |                                 |     |                             |                                 |                |
|  | LM2940, LM2940/883                 | -30 | -15/ <b>-15</b>             | -15/ <b>-15</b>                 |     |                             | -15/ <b>-15</b>                 | $V_{MIN}$      |
|  | LM2940C                            | -30 | -15                         |                                 | -30 | -15                         |                                 |                |
| Reverse Polarity Transient Input Voltage | $R_O = 100\Omega$                  |     |                             |                                 |     |                             |                                 |                |
|  | LM2940, $T \leq 100 \text{ ms}$    | -75 | -50/ <b>-50</b>             |                                 |     |                             |                                 | $V_{MIN}$      |
|  | LM2940/883, $T \leq 20 \text{ ms}$ |     |                             | -45/ <b>-45</b>                 |     |                             | -45/ <b>-45</b>                 |                |
|  | LM2940C, $T \leq 1 \text{ ms}$     | -55 | -45/ <b>-45</b>             |                                 | -55 | -45/ <b>-45</b>             |                                 |                |

**Note 1:** Absolute Maximum Ratings are limits beyond which damage to the device may occur. Operating Conditions are conditions under which the device functions but the specifications might not be guaranteed. For guaranteed specifications and test conditions see the Electrical Characteristics.

**Note 2:** The maximum allowable power dissipation is a function of the maximum junction temperature,  $T_J$ , the junction-to-ambient thermal resistance,  $\theta_{J-A}$ , and the ambient temperature,  $T_A$ . Exceeding the maximum allowable power dissipation will cause excessive die temperature, and the regulator will go into thermal shutdown. The value of  $\theta_{J-A}$  (for devices in still air with no heatsink) is  $60^\circ C/W$  for the TO-220 package,  $80^\circ C/W$  for the TO-263 package, and  $174^\circ C/W$  for the SOT-223 package. The effective value of  $\theta_{J-A}$  can be reduced by using a heatsink (see Application Hints for specific information on heatsinking). The values of  $\theta_{J-A}$  and  $\theta_{J-C}$  for the K02A package are  $39^\circ C/W$  and  $4^\circ C/W$  respectively.

**Note 3:** ESD rating is based on the human body model, 100 pF discharged through 1.5 k $\Omega$ .

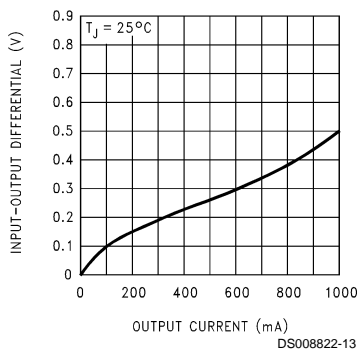
**Note 4:** All limits are guaranteed at  $T_A = T_J = 25^\circ C$  only (standard typeface) or over the entire operating temperature range of the indicated device (boldface type). All limits at  $T_A = T_J = 25^\circ C$  are 100% production tested. All limits at temperature extremes are guaranteed via correlation using standard Statistical Quality Control methods.

**Note 5:** All limits are guaranteed at  $T_A = T_J = 25^\circ C$  only (standard typeface) or over the entire operating temperature range of the indicated device (boldface type). All limits are 100% production tested and are used to calculate Outgoing Quality Levels.

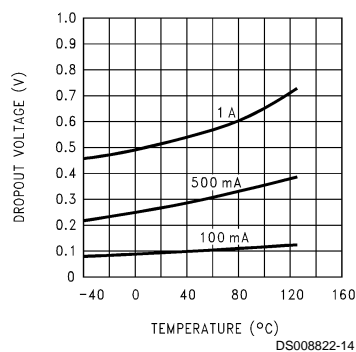
**Note 6:** Output current will decrease with increasing temperature but will not drop below 1A at the maximum specified temperature.

## Typical Performance Characteristics

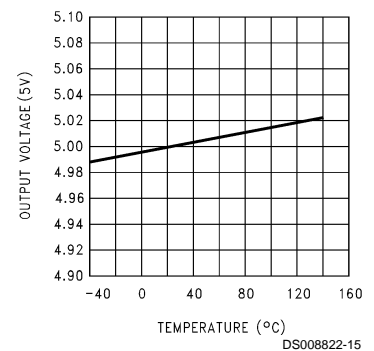
### Dropout Voltage



### Dropout Voltage vs Temperature

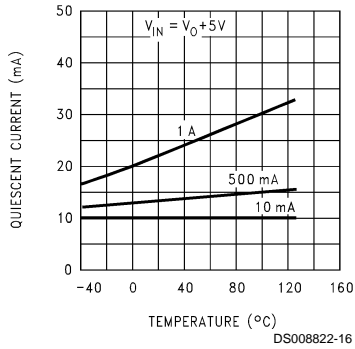


### Output Voltage vs Temperature

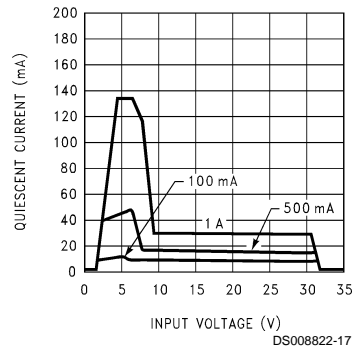


# Typical Performance Characteristics (Continued)

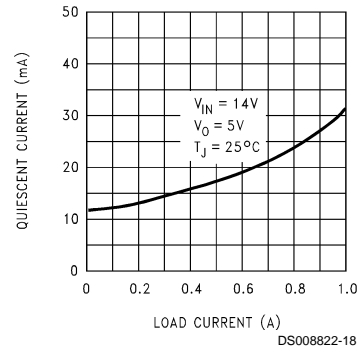
**Quiescent Current vs Temperature**



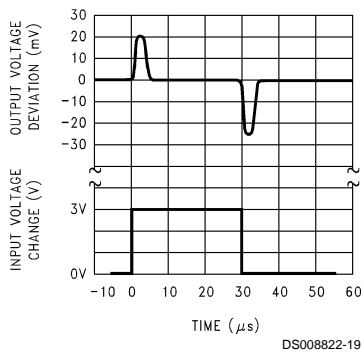
**Quiescent Current**



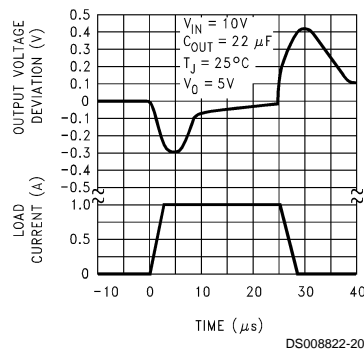
**Quiescent Current**



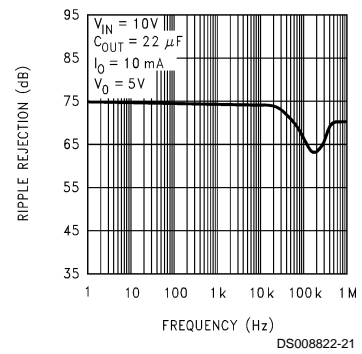
**Line Transient Response**



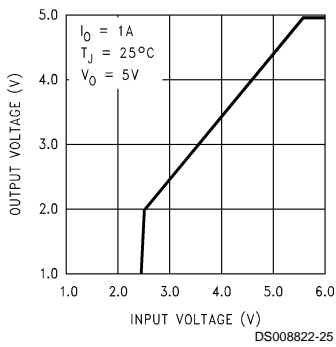
**Load Transient Response**



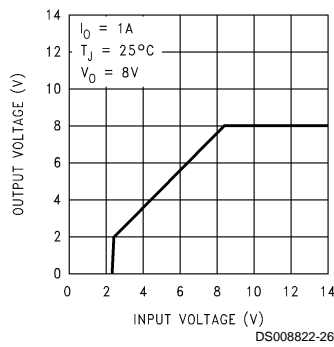
**Ripple Rejection**



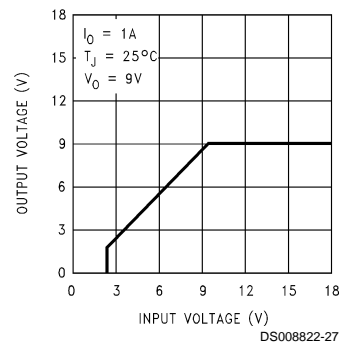
**Low Voltage Behavior**



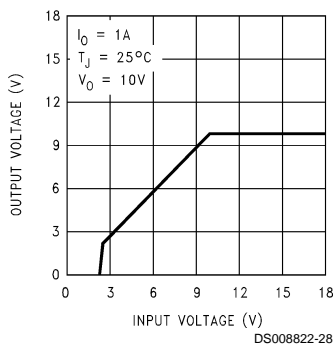
**Low Voltage Behavior**



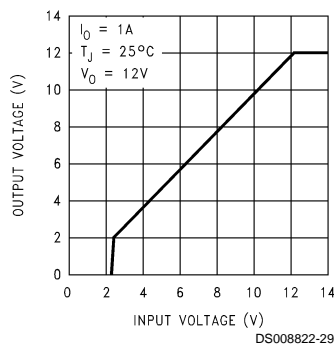
**Low Voltage Behavior**



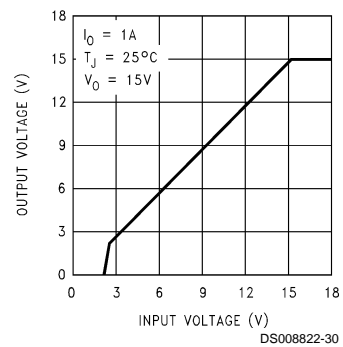
**Low Voltage Behavior**



**Low Voltage Behavior**

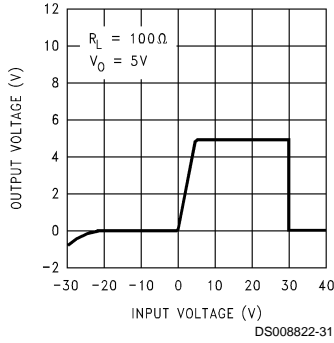


**Low Voltage Behavior**

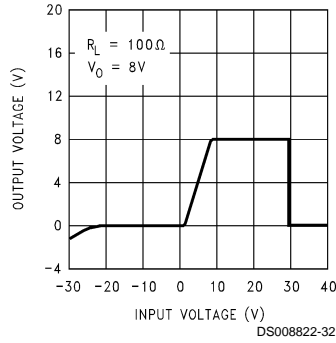


# Typical Performance Characteristics (Continued)

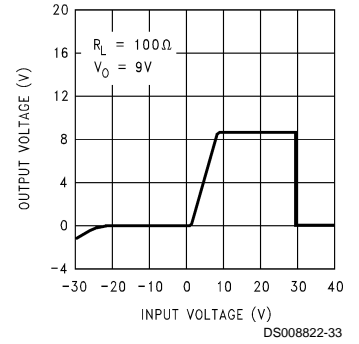
**Output at Voltage Extremes**



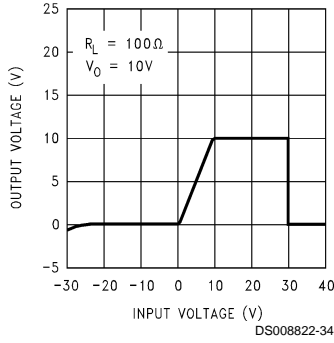
**Output at Voltage Extremes**



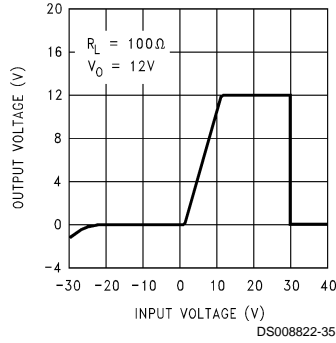
**Output at Voltage Extremes**



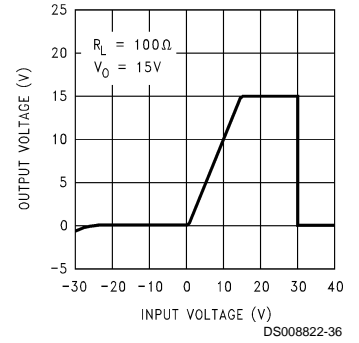
**Output at Voltage Extremes**



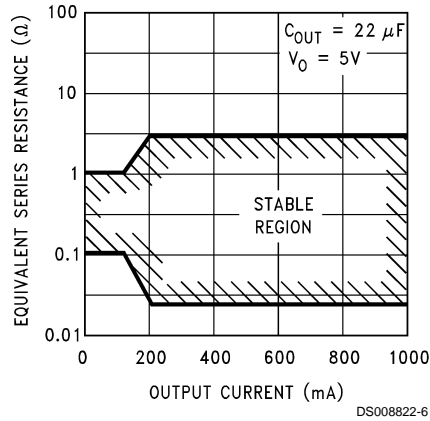
**Output at Voltage Extremes**



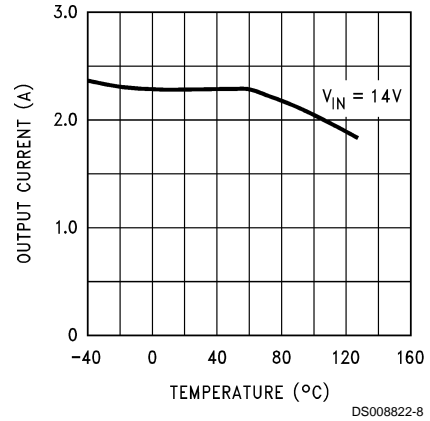
**Output at Voltage Extremes**



**Output Capacitor ESR**



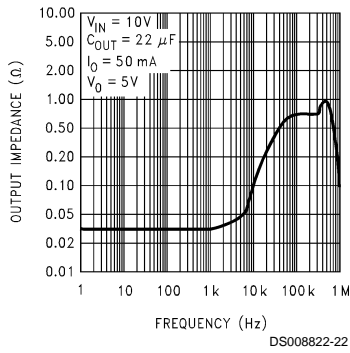
**Peak Output Current**



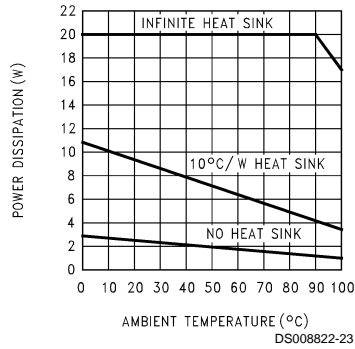


# Typical Performance Characteristics (Continued)

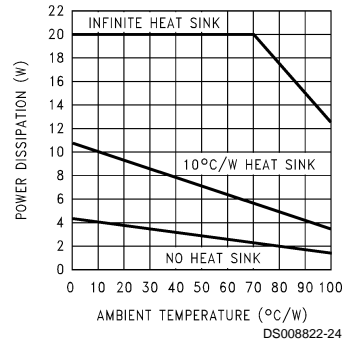
## Output Impedance



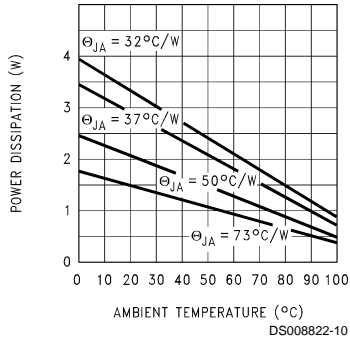
## Maximum Power Dissipation (TO-220)



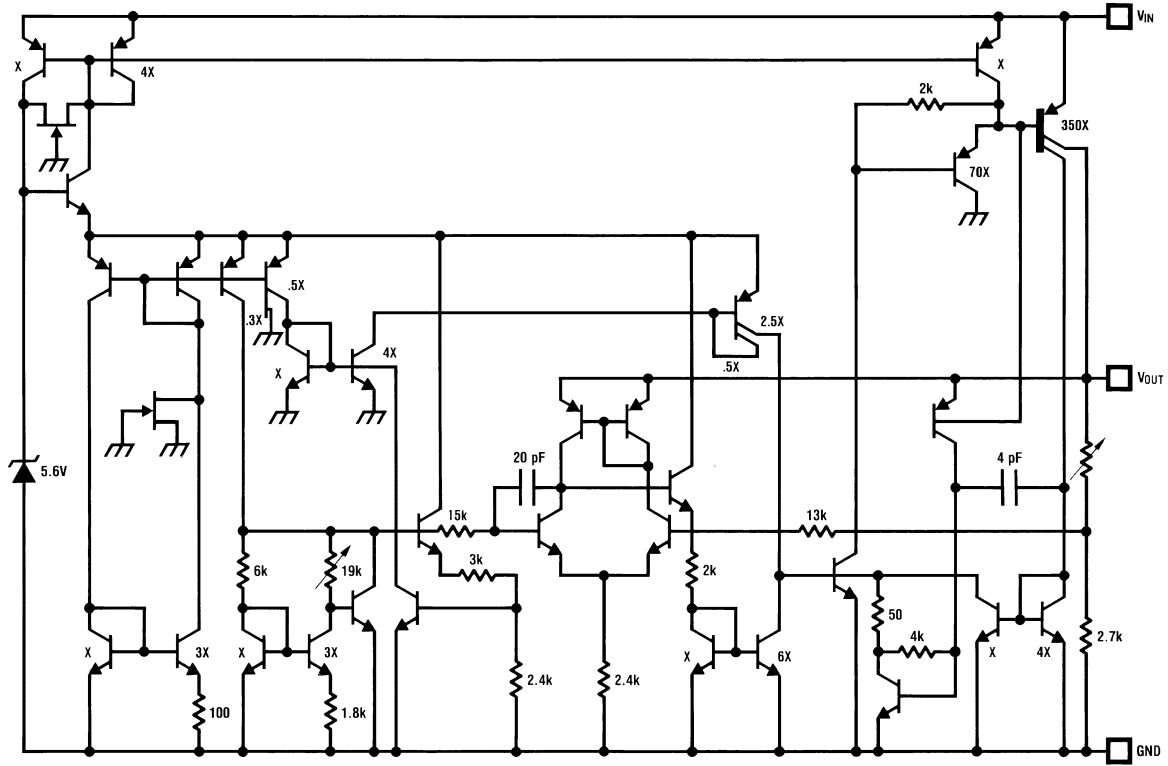
## Maximum Power Dissipation (TO-3)



## Maximum Power Dissipation (TO-263) See (Note 2)



## Equivalent Schematic Diagram



DS008822-1

## Application Hints

### EXTERNAL CAPACITORS

The output capacitor is critical to maintaining regulator stability, and must meet the required conditions for both ESR (Equivalent Series Resistance) and minimum amount of capacitance.

### MINIMUM CAPACITANCE:

The minimum output capacitance required to maintain stability is 22  $\mu\text{F}$  (this value may be increased without limit). Larger values of output capacitance will give improved transient response.

### ESR LIMITS:

The ESR of the output capacitor will cause loop instability if it is too high or too low. The acceptable range of ESR plotted versus load current is shown in the graph below. **It is essential that the output capacitor meet these requirements, or oscillations can result.**

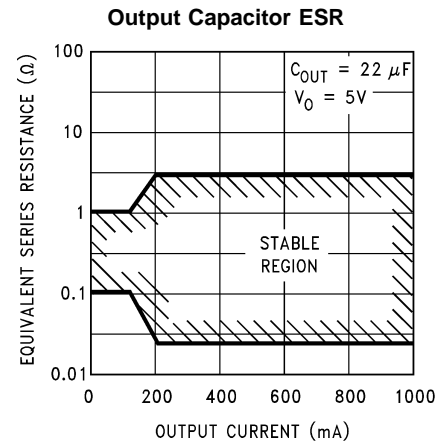


FIGURE 1. ESR Limits

It is important to note that for most capacitors, ESR is specified only at room temperature. However, the designer must ensure that the ESR will stay inside the limits shown over the entire operating temperature range for the design.

For aluminum electrolytic capacitors, ESR will increase by about 30X as the temperature is reduced from 25°C to -40°C. This type of capacitor is not well-suited for low temperature operation.

Solid tantalum capacitors have a more stable ESR over temperature, but are more expensive than aluminum electrolytics. A cost-effective approach sometimes used is to parallel

## Application Hints (Continued)

an aluminum electrolytic with a solid Tantalum, with the total capacitance split about 75/25% with the Aluminum being the larger value.

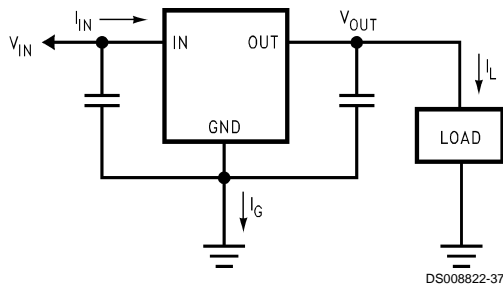
If two capacitors are paralleled, the effective ESR is the parallel of the two individual values. The “flatter” ESR of the Tantalum will keep the effective ESR from rising as quickly at low temperatures.

### HEATSINKING

A heatsink may be required depending on the maximum power dissipation and maximum ambient temperature of the application. Under all possible operating conditions, the junction temperature must be within the range specified under Absolute Maximum Ratings.

To determine if a heatsink is required, the power dissipated by the regulator,  $P_D$ , must be calculated.

The figure below shows the voltages and currents which are present in the circuit, as well as the formula for calculating the power dissipated in the regulator:



$$I_{IN} = I_L + I_G$$

$$P_D = (V_{IN} - V_{OUT}) I_L + (V_{IN}) I_G$$

**FIGURE 2. Power Dissipation Diagram**

The next parameter which must be calculated is the maximum allowable temperature rise,  $T_R$  (max). This is calculated by using the formula:

$$T_R (\text{max}) = T_J (\text{max}) - T_A (\text{max})$$

where:  $T_J$  (max) is the maximum allowable junction temperature, which is 125°C for commercial grade parts.

$T_A$  (max) is the maximum ambient temperature which will be encountered in the application.

Using the calculated values for  $T_R$ (max) and  $P_D$ , the maximum allowable value for the junction-to-ambient thermal resistance,  $\theta_{(J-A)}$ , can now be found:

$$\theta_{(J-A)} = T_R (\text{max})/P_D$$

**IMPORTANT:** If the maximum allowable value for  $\theta_{(J-A)}$  is found to be  $\geq 53^\circ\text{C/W}$  for the TO-220 package,  $\geq 80^\circ\text{C/W}$  for the TO-263 package, or  $\geq 174^\circ\text{C/W}$  for the SOT-223 package, no heatsink is needed since the package alone will dissipate enough heat to satisfy these requirements.

If the calculated value for  $\theta_{(J-A)}$  falls below these limits, a heatsink is required.

### HEATSINKING TO-220 PACKAGE PARTS

The TO-220 can be attached to a typical heatsink, or secured to a copper plane on a PC board. If a copper plane is to be used, the values of  $\theta_{(J-A)}$  will be the same as shown in the next section for the TO-263.

If a manufactured heatsink is to be selected, the value of heatsink-to-ambient thermal resistance,  $\theta_{(H-A)}$ , must first be calculated:

$$\theta_{(H-A)} = \theta_{(J-C)} - \theta_{(C-H)} - \theta_{(J-C)}$$

Where:  $\theta_{(J-C)}$  is defined as the thermal resistance from the junction to the surface of the case. A value of  $3^\circ\text{C/W}$  can be assumed for  $\theta_{(J-C)}$  for this calculation.

$\theta_{(C-H)}$  is defined as the thermal resistance between the case and the surface of the heat-sink. The value of  $\theta_{(C-H)}$  will vary from about  $1.5^\circ\text{C/W}$  to about  $2.5^\circ\text{C/W}$  (depending on method of attachment, insulator, etc.). If the exact value is unknown,  $2^\circ\text{C/W}$  should be assumed for  $\theta_{(C-H)}$ .

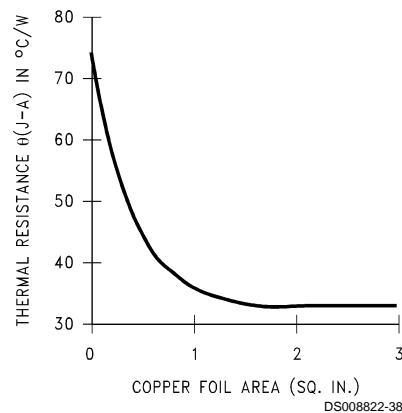
When a value for  $\theta_{(H-A)}$  is found using the equation shown, *a heatsink must be selected that has a value that is less than or equal to this number.*

$\theta_{(H-A)}$  is specified numerically by the heatsink manufacturer in the catalog, or shown in a curve that plots temperature rise vs power dissipation for the heatsink.

### HEATSINKING TO-263 AND SOT-223 PACKAGE PARTS

Both the TO-263 (“S”) and SOT-223 (“MP”) packages use a copper plane on the PCB and the PCB itself as a heatsink. To optimize the heat sinking ability of the plane and PCB, solder the tab of the package to the plane.

Figure 3 shows for the TO-263 the measured values of  $\theta_{(J-A)}$  for different copper area sizes using a typical PCB with 1 ounce copper and no solder mask over the copper area used for heatsinking.

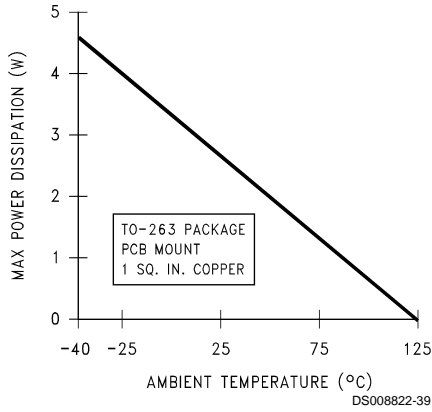


**FIGURE 3.  $\theta_{(J-A)}$  vs Copper (1 ounce) Area for the TO-263 Package**

As shown in the figure, increasing the copper area beyond 1 square inch produces very little improvement. It should also be observed that the minimum value of  $\theta_{(J-A)}$  for the TO-263 package mounted to a PCB is  $32^\circ\text{C/W}$ .

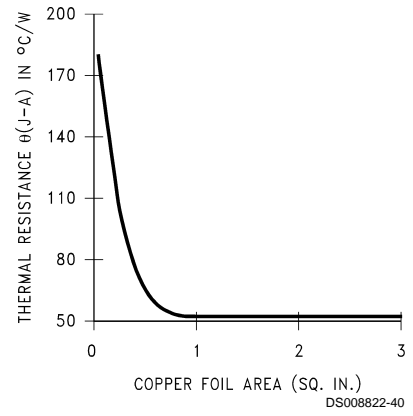
As a design aid, Figure 4 shows the maximum allowable power dissipation compared to ambient temperature for the TO-263 device (assuming  $\theta_{(J-A)}$  is  $35^\circ\text{C/W}$  and the maximum junction temperature is  $125^\circ\text{C}$ ).

Application Hints (Continued)

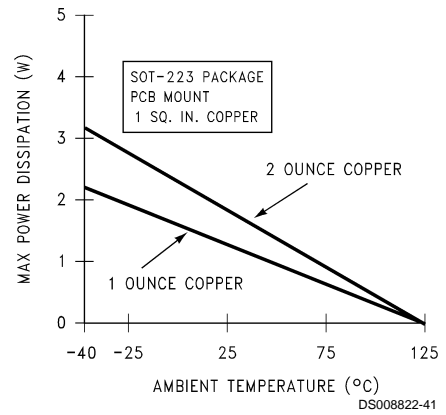


**FIGURE 4. Maximum Power Dissipation vs T<sub>AMB</sub> for the TO-263 Package**

Figure 5 and Figure 6 show the information for the SOT-223 package. Figure 6 assumes a  $\theta_{(J-A)}$  of 74°C/W for 1 ounce copper and 51°C/W for 2 ounce copper and a maximum junction temperature of 125°C.

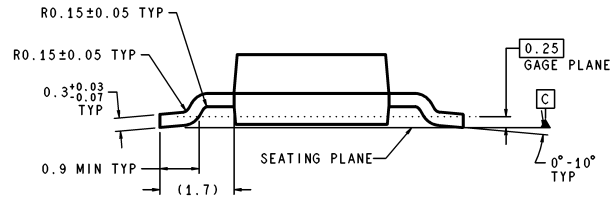
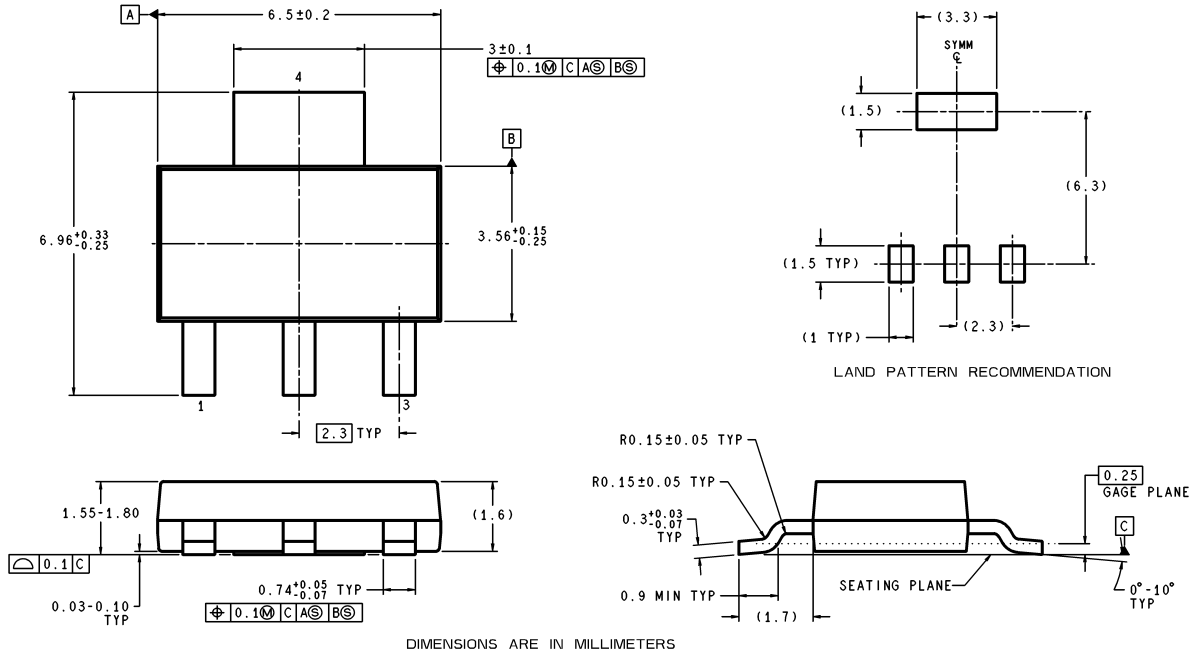


**FIGURE 5.  $\theta_{(J-A)}$  vs Copper (2 ounce) Area for the SOT-223 Package**



**FIGURE 6. Maximum Power Dissipation vs T<sub>AMB</sub> for the SOT-223 Package**

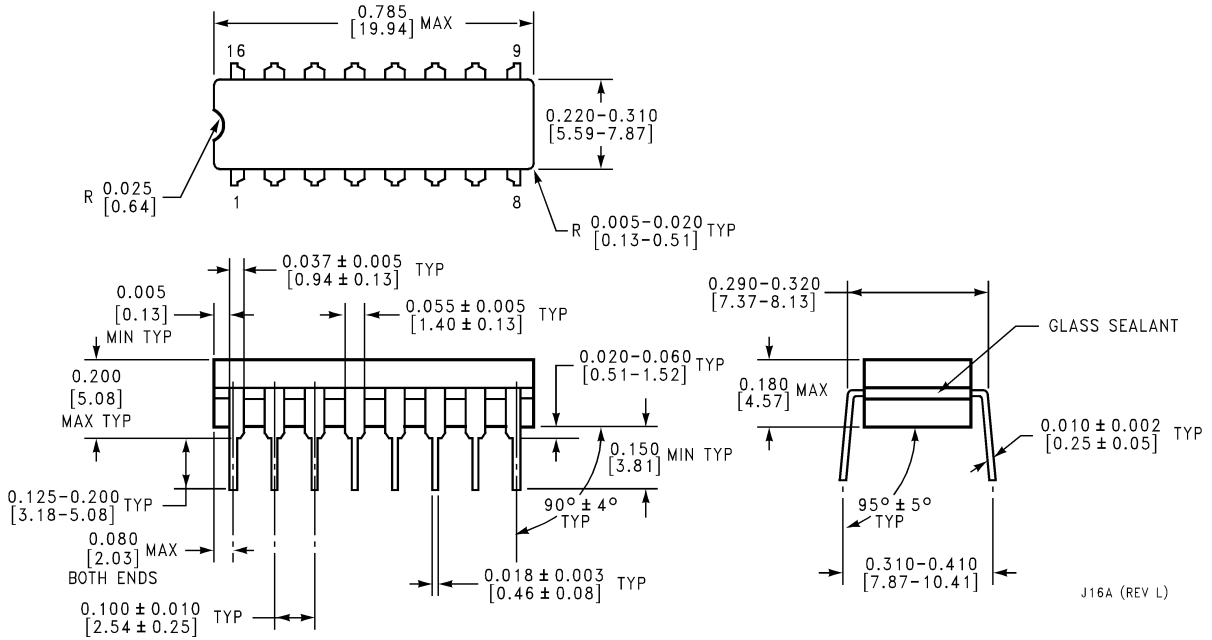
**Physical Dimensions** inches (millimeters) unless otherwise noted



MP04A (Rev A)

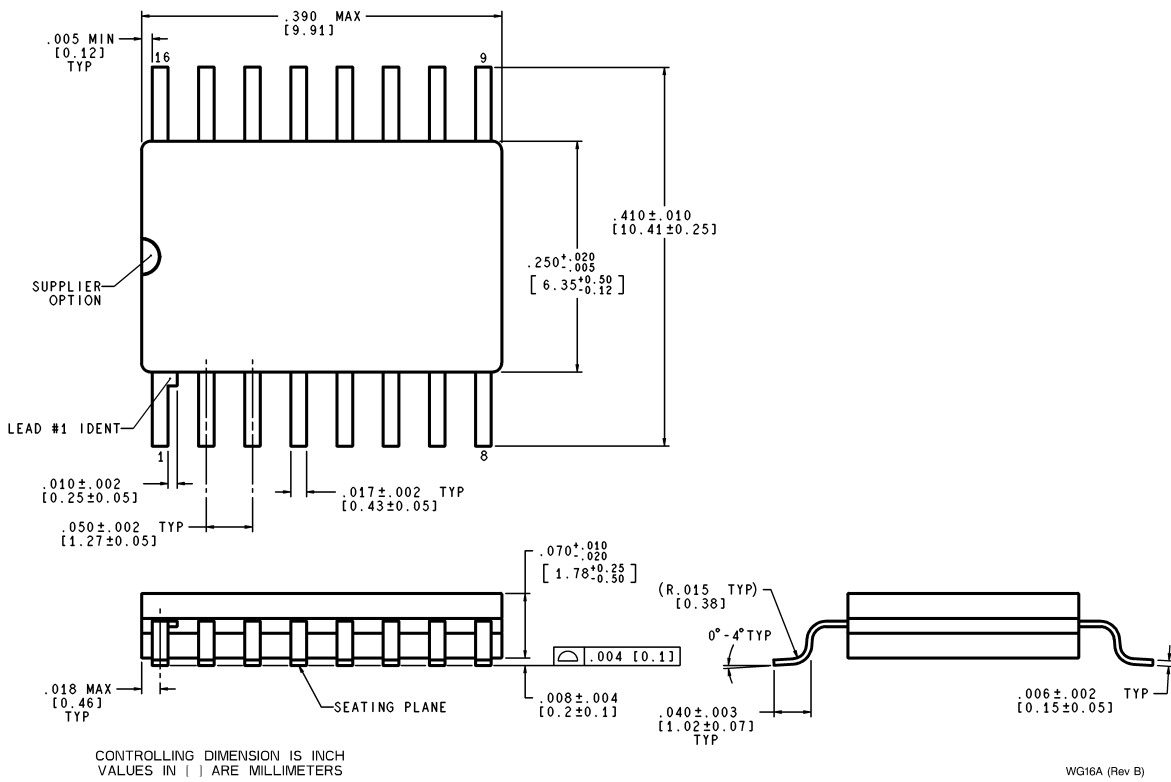
**3-Lead SOT-223 Package**  
**Order Part Number LM2940IMP-5.0**  
**LM2940IMP-8.0 LM2940IMP-9.0**  
**LM2940IMP-10 LM2940IMP-12 LM2940IMP-15**  
**NS Package Number MP04A**

**Physical Dimensions** inches (millimeters) unless otherwise noted (Continued)



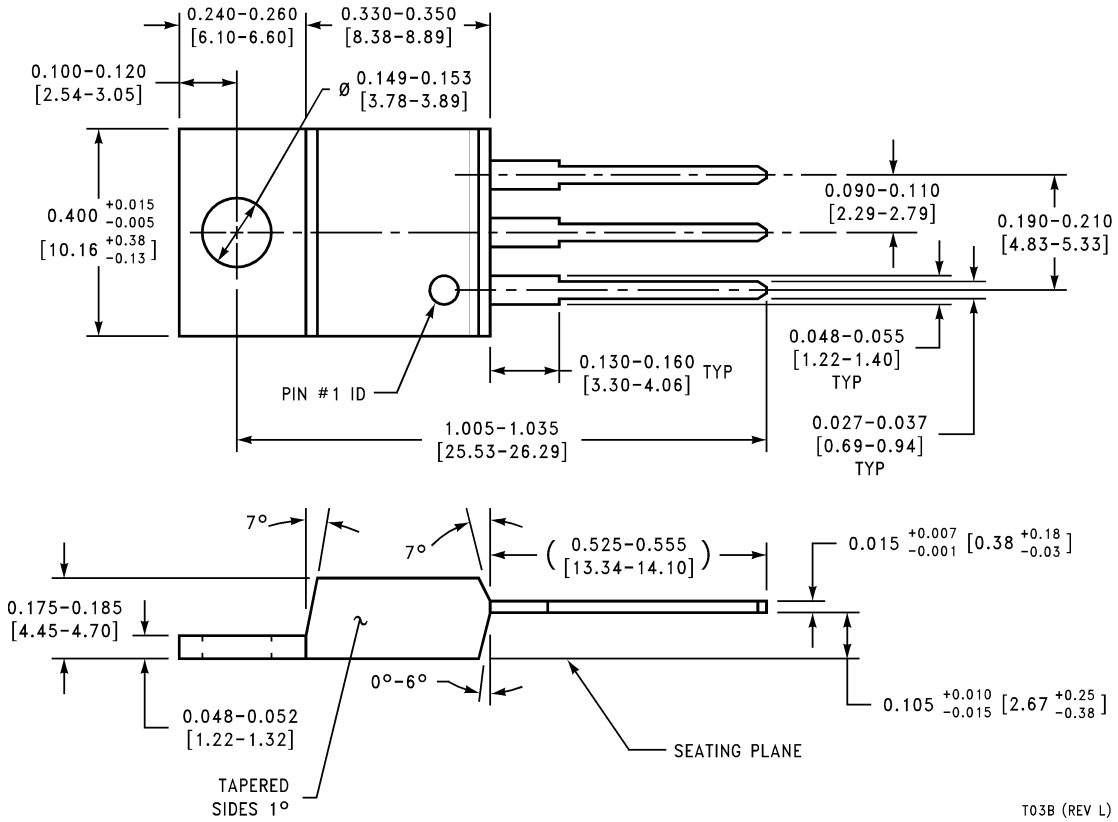
**16 Lead Dual-in-Line Package (J)**  
**Order Number LM2940J-5.0/883 (5962-8958701EA),**  
**LM2940J-8.0/883 (5962-9088301QEA),**  
**LM2940J-12/883 (5962-9088401QEA),**  
**LM2940J-15/883 (5962-9088501QEA)**  
**See NS Package Number J16A**

**Physical Dimensions** inches (millimeters) unless otherwise noted (Continued)



**16 Lead Surface Mount Package (WG)**  
**Order Number LM2940WG5.0/883 (5962-8958701XA)**  
**See NS Package Number WG16A**

**Physical Dimensions** inches (millimeters) unless otherwise noted (Continued)

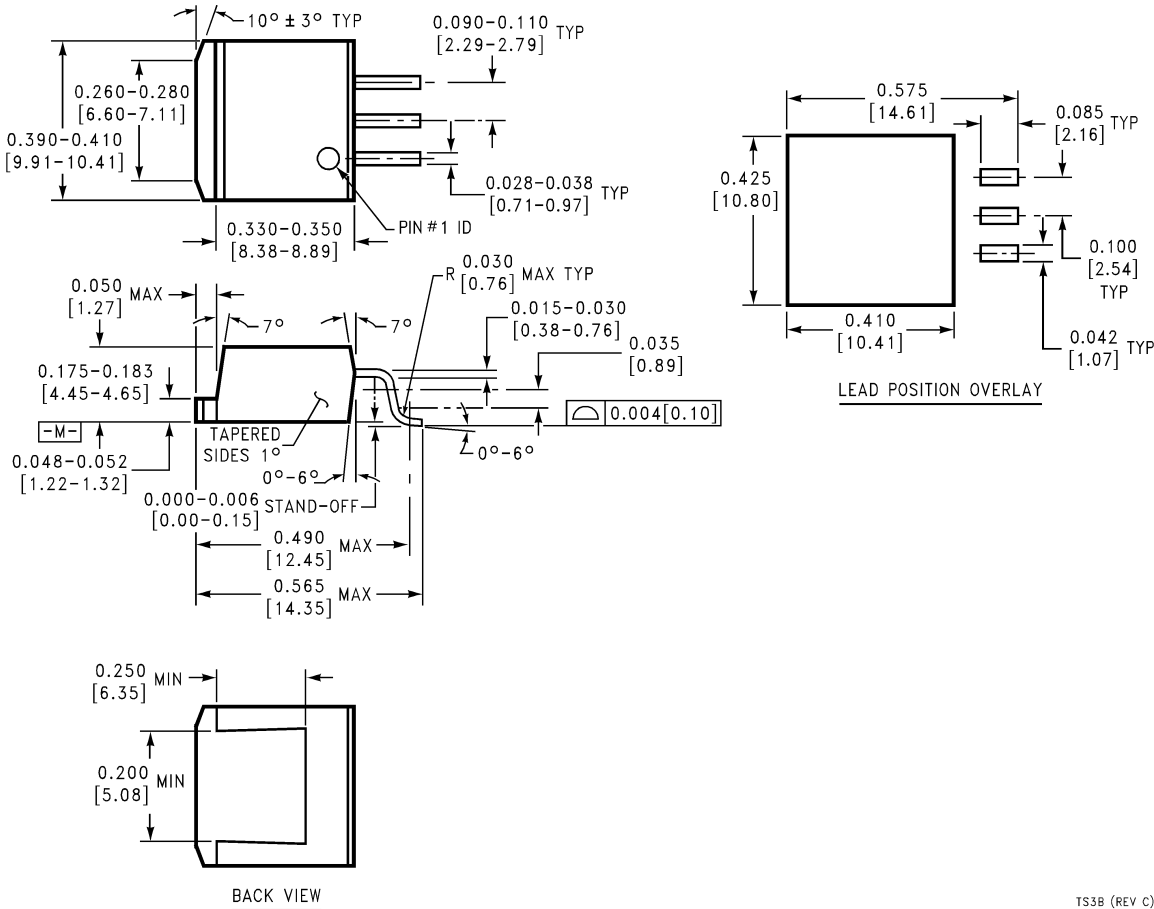


T03B (REV L)

**3-Lead TO-220 Plastic Package (T)**  
**Order Number LM2940T-5.0, LM2940T-8.0,**  
**LM2940T-9.0, LM2940T-10, LM2940T-12, LM2940CT-5.0,**  
**LM2940CT-12 or LM2940CT-15**  
**NS Package Number T03B**



**Physical Dimensions** inches (millimeters) unless otherwise noted (Continued)



**3-Lead TO-263 Surface Mount Package (MP)**  
**Order Number LM2940S-5.0, LM2940S-8.0,**  
**LM2940S-9.0, LM2940S-10, LM2940S-12,**  
**LM2940CS-5.0, LM2940CS-12 or LM2940CS-15**  
**NS Package Number TS3B**

TS3B (REV C)

**LIFE SUPPORT POLICY**

NATIONAL'S PRODUCTS ARE NOT AUTHORIZED FOR USE AS CRITICAL COMPONENTS IN LIFE SUPPORT DEVICES OR SYSTEMS WITHOUT THE EXPRESS WRITTEN APPROVAL OF THE PRESIDENT AND GENERAL COUNSEL OF NATIONAL SEMICONDUCTOR CORPORATION. As used herein:

1. Life support devices or systems are devices or systems which, (a) are intended for surgical implant into the body, or (b) support or sustain life, and whose failure to perform when properly used in accordance with instructions for use provided in the labeling, can be reasonably expected to result in a significant injury to the user.
2. A critical component is any component of a life support device or system whose failure to perform can be reasonably expected to cause the failure of the life support device or system, or to affect its safety or effectiveness.



**National Semiconductor Corporation**  
Americas  
Tel: 1-800-272-9959  
Fax: 1-800-737-7018  
Email: support@nsc.com  
www.national.com

**National Semiconductor Europe**  
Fax: +49 (0) 180-530 85 86  
Email: europe.support@nsc.com  
Deutsch Tel: +49 (0) 69 9508 6208  
English Tel: +44 (0) 870 24 0 2171  
Français Tel: +33 (0) 1 41 91 8790

**National Semiconductor Asia Pacific Customer Response Group**  
Tel: 65-2544466  
Fax: 65-2504466  
Email: ap.support@nsc.com

**National Semiconductor Japan Ltd.**  
Tel: 81-3-5639-7560  
Fax: 81-3-5639-7507