

FEATURES

- Ultra Low Dropout Voltage
- Low Ground Pin Current
- Excellent Line and Load Regulation
- Guaranteed Output Current of 1.5A
- Available in MSOP8, SOP8, SOP8-PP, SOT-223, TO-252, TO-263, TO-220, and SOT-89 Packages
- Fixed Output Voltages : 1.2V, 1.8V, 2.5V, 3.3V, and 5.0V
- SENSE Option Improves Load Regulation
- Over-Temperature/Over-Current Protection
- -40°C to 125°C Junction Temperature Range
- Moisture Sensitivity Level 3

APPLICATION

- Battery Powered Equipments
- Motherboards and Graphic Cards
- Microprocessor Power Supplies
- Peripheral Cards
- High Efficiency Linear Regulators
- Battery Chargers

DESCRIPTION

The TJ3965 series of high performance ultra low-dropout linear regulators operates from 2.5V to 6V input supply and provides ultra low-dropout voltage, high output current with low ground current. Wide range of preset output voltage options are available. These ultra low dropout linear regulators respond fast to step changes in load which makes them suitable for low voltage micro-processor applications. The TJ3965 is developed on a CMOS process technology which allows low quiescent current operation independent of output load current. This CMOS process also allows the TJ3965 to operate under extremely low dropout conditions.

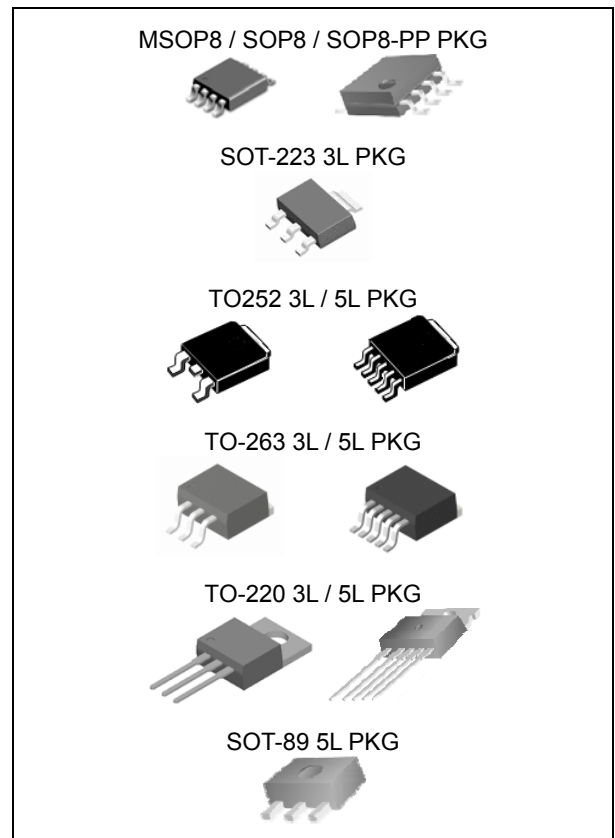

ORDERING INFORMATION

Device	Package
TJ3965MD-ADJ	MSOP8
TJ3965MD-X.X	
TJ3965D-ADJ	SOP8
TJ3965D-X.X	
TJ3965DP-ADJ	SOP8-PP
TJ3965DP-X.X	
3965S-X.X	SOT-223 3L
TJ3965GRS-ADJ	TO-252 3L/5L
TJ3965GRS-X.X	
TJ3965GR-ADJ	TO-263 3L/5L
TJ3965GR-X.X	
TJ3965T-ADJ	TO-220 3L/5L
TJ3965T-X.X	
3965F-ADJ	SOT-89 5L
3965F-X.X	

X.X = Output Voltage = 1.2, 1.8, 2.5, 3.3, and 5.0

Absolute Maximum Ratings

CHARACTERISTIC	SYMBOL	MIN.	MAX.	UNIT
Input Supply Voltage (Survival)	V_{IN}	-0.3	6.5	V
Enable Input Voltage (Survival)	$V_{EN}^{(1)}$	-0.3	6.5	V
Maximum Output Current	I_{MAX}	-	1.5	A
Lead Temperature (Soldering, 5 sec)	T_{SOL}		260	°C
Storage Temperature Range	T_{STG}	-65	150	°C
Operating Junction Temperature Range	T_{JOPR}	-40	125	°C

(1) It is recommended for V_{EN} voltage not to exceed V_{IN} voltage.

Ordering Information

V _{OUT}	Package	Order No.	Description	Supplied As	Status
ADJ	MSOP8	TJ3965MD-ADJ-8L	1.5A, Adjustable, Enable	Reel	Contact us
	SOP8	TJ3965D-ADJ-8L	1.5A, Adjustable, Enable	Reel	Active
	SOP8-PP	TJ3965DP-ADJ-8L	1.5A, Adjustable, Enable	Reel	Active
	TO-252 5L	TJ3965RS-ADJ-5L	1.5A, Adjustable, Enable	Reel	Obsolete
	TO-252 5L	TJ3965GRS-ADJ-5L	1.5A, Adjustable, Enable	Reel	Active
	TO-263 5L	TJ3965R-ADJ-5L	1.5A, Adjustable, Enable	Reel	Obsolete
	TO-263 5L	TJ3965GR-ADJ-5L	1.5A, Adjustable, Enable	Reel	Active
	TO-220 5L	TJ3965T-ADJ-5L	1.5A, Adjustable, Enable	Tube	Active
	SOT-89 5L	TJ3965F-ADJ-5L	1.5A, Adjustable, Enable	Reel	Active
1.2V	MSOP8	TJ3965MD-1.2V-8L	1.5A, Enable, SENSE	Reel	Contact us
	SOP8	TJ3965D-1.2V-8L	1.5A, Enable, SENSE	Reel	Active
	SOP8-PP	TJ3965DP-1.2-8L	1.5A, Enable, SENSE	Reel	Active
	SOT-223 3L	TJ3965S-1.2V-3L	1.5A	Reel	Active
	TO-252 3L	TJ3965RS-1.2V-3L	1.5A	Reel	Obsolete
	TO-252 3L	TJ3965GRS-1.2V-3L	1.5A	Reel	Active
	TO-252 5L	TJ3965RS-1.2V-5L	1.5A, Enable, SENSE	Reel	Obsolete
	TO-252 5L	TJ3965GRS-1.2V-5L	1.5A, Enable, SENSE	Reel	Active
	TO-263 3L	TJ3965R-1.2V-3L	1.5A	Reel	Obsolete
	TO-263 3L	TJ3965GR-1.2V-3L	1.5A	Reel	Active
	TO-263 5L	TJ3965R-1.2V-5L	1.5A, Enable, SENSE	Reel	Obsolete
	TO-263 5L	TJ3965GR-1.2V-5L	1.5A, Enable, SENSE	Reel	Active
	TO-220 3L	TJ3965T-1.2V-3L	1.5A	Tube	Active
	TO-220 5L	TJ3965T-1.2V-5L	1.5A, Enable, SENSE	Tube	Active
SOT-89 5L	TJ3965F-1.2V-5L	1.5A, Enable, SENSE	Reel	Active	
1.8V	MSOP8	TJ3965MD-1.8V-8L	1.5A, Enable, SENSE	Reel	Contact us
	SOP8	TJ3965D-1.8V-8L	1.5A, Enable, SENSE	Reel	Active
	SOP8-PP	TJ3965DP-1.8V-8L	1.5A, Enable, SENSE	Reel	Active
	SOT-223 3L	TJ3965S-1.8V-3L	1.5A	Reel	Active
	TO -252 3L	TJ3965RS-1.8V-3L	1.5A	Reel	Obsolete
	TO -252 3L	TJ3965GRS-1.8V-3L	1.5A	Reel	Active
	TO -252 5L	TJ3965RS-1.8V-5L	1.5A, Enable, SENSE	Reel	Obsolete
	TO -252 5L	TJ3965GRS-1.8V-5L	1.5A, Enable, SENSE	Reel	Active
	TO -263 3L	TJ3965R-1.8V-3L	1.5A	Reel	Obsolete
	TO -263 3L	TJ3965GR-1.8V-3L	1.5A	Reel	Active
	TO -263 5L	TJ3965R-1.8V-5L	1.5A, Enable, SENSE	Reel	Obsolete
	TO -263 5L	TJ3965GR-1.8V-5L	1.5A, Enable, SENSE	Reel	Active
	TO-220 3L	TJ3965T-1.8V-3L	1.5A	Tube	Active
	TO-220 5L	TJ3965T-1.8V-5L	1.5A, Enable, SENSE	Tube	Active
SOT-89 5L	TJ3965F-1.8V-5L	1.5A, Enable, SENSE	Reel	Active	

1.5A Ultra Low Dropout Linear Regulator

TJ3965

Ordering Information

(Continued)

V _{OUT}	Package	Order No.	Description	Supplied As	Status
2.5V	MSOP8	TJ3965MD-2.5V-8L	1.5A, Enable, SENSE	Reel	Contact us
	SOP8	TJ3965D-2.5V-8L	1.5A, Enable, SENSE	Reel	Active
	SOP8-PP	TJ3965DP-2.5V-8L	1.5A, Enable, SENSE	Reel	Active
	SOT-223 3L	TJ3965S-2.5V-3L	1.5A	Reel	Active
	TO -252 3L	TJ3965RS-2.5V-3L	1.5A	Reel	Obsolete
	TO -252 3L	TJ3965GRS-2.5V-3L	1.5A	Reel	Active
	TO -252 5L	TJ3965RS-2.5V-5L	1.5A, Enable, SENSE	Reel	Obsolete
	TO -252 5L	TJ3965GRS-2.5V-5L	1.5A, Enable, SENSE	Reel	Active
	TO -263 3L	TJ3965R-2.5V-3L	1.5A	Reel	Obsolete
	TO -263 3L	TJ3965GR-2.5V-3L	1.5A	Reel	Active
	TO -263 5L	TJ3965R-2.5V-5L	1.5A, Enable, SENSE	Reel	Obsolete
	TO -263 5L	TJ3965GR-2.5V-5L	1.5A, Enable, SENSE	Reel	Active
	TO-220 3L	TJ3965T-2.5V-3L	1.5A	Tube	Active
	TO-220 5L	TJ3965T-2.5V-5L	1.5A, Enable, SENSE	Tube	Active
	SOT-89 5L	TJ3965F-2.5V-5L	1.5A, Enable, SENSE	Reel	Active
3.3V	MSOP8	TJ3965MD-3.3V-8L	1.5A, Enable, SENSE	Reel	Contact us
	SOP8	TJ3965D-3.3V-8L	1.5A, Enable, SENSE	Reel	Active
	SOP8-PP	TJ3965DP-3.3V-8L	1.5A, Enable, SENSE	Reel	Active
	SOT-223 3L	TJ3965S-3.3V-3L	1.5A	Reel	Active
	TO -252 3L	TJ3965RS-3.3V-3L	1.5A	Reel	Obsolete
	TO -252 3L	TJ3965GRS-3.3V-3L	1.5A	Reel	Active
	TO -252 5L	TJ3965RS-3.3V-5L	1.5A, Enable, SENSE	Reel	Obsolete
	TO -252 5L	TJ3965GRS-3.3V-5L	1.5A, Enable, SENSE	Reel	Active
	TO -263 3L	TJ3965R-3.3V-3L	1.5A	Reel	Obsolete
	TO -263 3L	TJ3965GR-3.3V-3L	1.5A	Reel	Active
	TO -263 5L	TJ3965R-3.3V-5L	1.5A, Enable, SENSE	Reel	Obsolete
	TO -263 5L	TJ3965GR-3.3V-5L	1.5A, Enable, SENSE	Reel	Active
	TO-220 3L	TJ3965T-3.3V-3L	1.5A	Tube	Active
	TO-220 5L	TJ3965T-3.3V-5L	1.5A, Enable, SENSE	Tube	Active
	SOT-89 5L	TJ3965F-3.3V-5L	1.5A, Enable, SENSE	Reel	Active
5.0V	MSOP8	TJ3965MD-5.0V-8L	1.5A, Enable, SENSE	Reel	Contact us
	SOP8	TJ3965D-5.0V-8L	1.5A, Enable, SENSE	Reel	Active
	SOP8-PP	TJ3965DP-5.0V-8L	1.5A, Enable, SENSE	Reel	Active
	SOT-223 3L	TJ3965S-5.0V-3L	1.5A	Reel	Active
	TO -252 3L	TJ3965RS-5.0V-3L	1.5A	Reel	Obsolete
	TO -252 3L	TJ3965GRS-5.0V-3L	1.5A	Reel	Active
	TO -252 5L	TJ3965RS-5.0V-5L	1.5A, Enable, SENSE	Reel	Obsolete
	TO -252 5L	TJ3965GRS-5.0V-5L	1.5A, Enable, SENSE	Reel	Active
	TO -263 3L	TJ3965R-5.0V-3L	1.5A	Reel	Obsolete
	TO -263 3L	TJ3965GR-5.0V-3L	1.5A	Reel	Active
	TO -263 5L	TJ3965R-5.0V-5L	1.5A, Enable, SENSE	Reel	Obsolete
	TO -263 5L	TJ3965GR-5.0V-5L	1.5A, Enable, SENSE	Reel	Active
	TO-220 3L	TJ3965T-5.0V-3L	1.5A	Tube	Active
	TO-220 5L	TJ3965T-5.0V-5L	1.5A, Enable, SENSE	Tube	Active
	SOT-89 5L	TJ3965F-5.0V-5L	1.5A, Enable, SENSE	Reel	Active

(Continued)

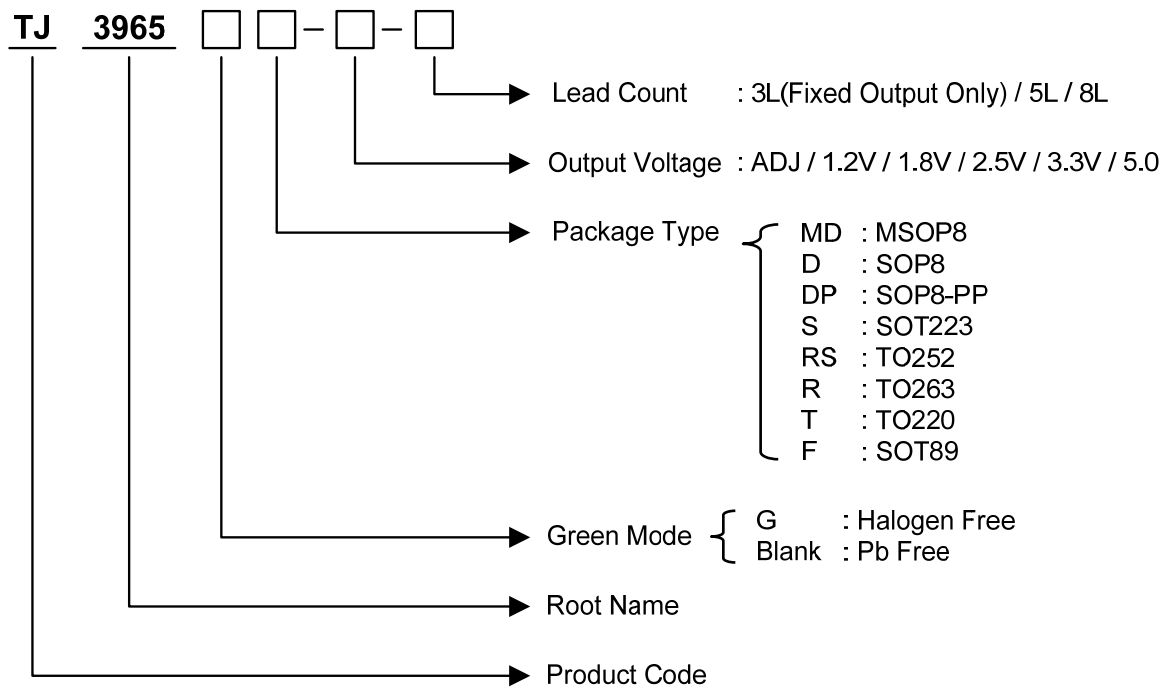

PIN CONFIGURATION

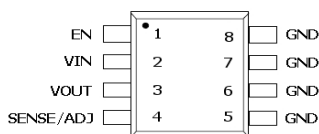

MSOP8

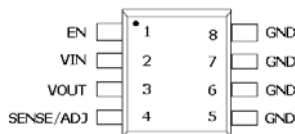

SOP8 / SOP8-PP

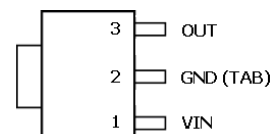

SOT223-3L

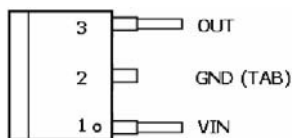

TO252-3L

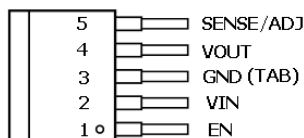

TO252-5L



TO263-3L

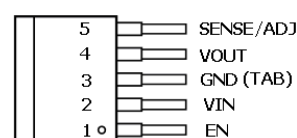

TO263-5L

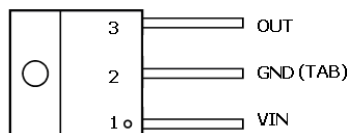

TO220-3L

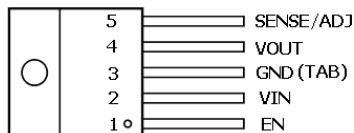

TO220-5L

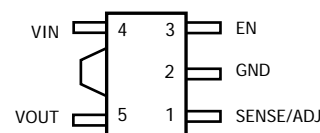

SOT89-5L

PIN DESCRIPTION

Pin No.	SOT223 / TO252 / TO263 / TO220 3LEAD		SOT-223 5LEAD		SOT-89 5LEAD	
	Name	Function	Name	Function	Name	Function
1	V _{IN}	Input Supply	EN	Chip Enable	SENSE/ADJ	Remote Sense or Output Adjust
2	GND	Ground	V _{IN}	Input Supply	GND	Ground
3	V _{OUT}	Output Voltage	V _{OUT}	Output Voltage	EN	Chip Enable
4	-	-	SENSE/ADJ	Remote Sense or Output Adjust	V _{IN}	Input Supply
5	-	-	GND	Ground	V _{OUT}	Output Voltage

Pin No.	TO252 / TO263 / TO220 5LEAD		MSOP8 / SOP8 / SOP8-PP 8LEAD	
	Name	Function	Name	Function
1	EN	Chip Enable	EN	Chip Enable
2	V _{IN}	Input Supply	V _{IN}	Input Supply
3	GND	Ground	V _{OUT}	Output Voltage
4	V _{OUT}	Output Voltage	SENSE/ADJ	Remote Sense or Output Adjust
5 / 6 / 7 / 8	SENSE/ADJ	Remote Sense or Output Adjust	GND	Ground

TYPICAL APPLICATION

Typical 3 Pin Application

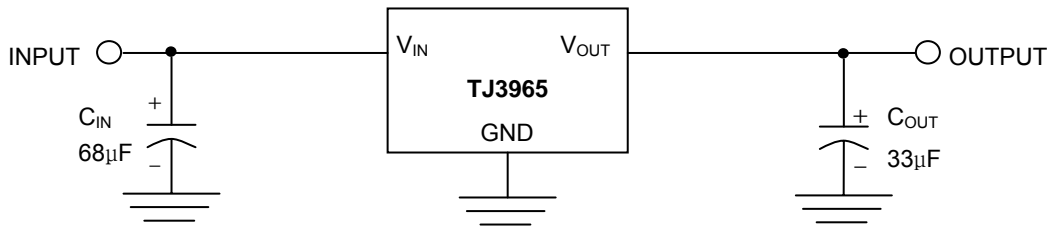

Typical 5 / 8 Pin Application

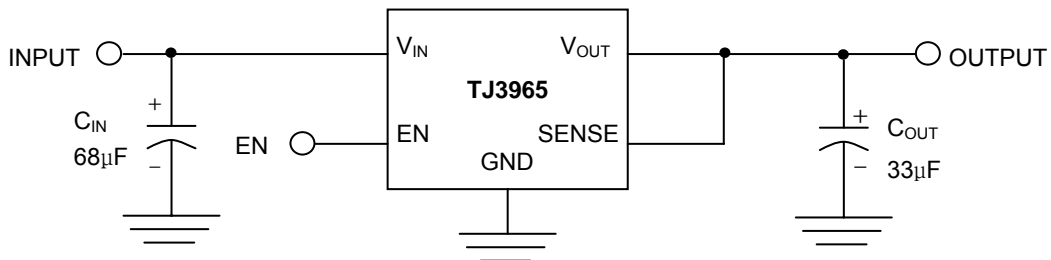

5 / 8 Pin Remote Load Sense Application

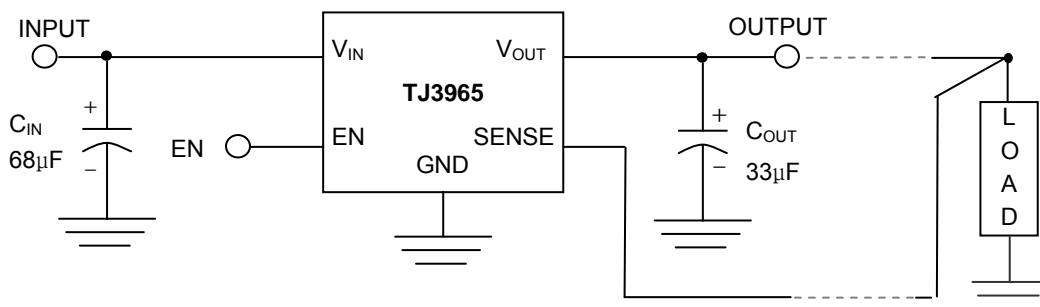

Typical Adjustable Version Application

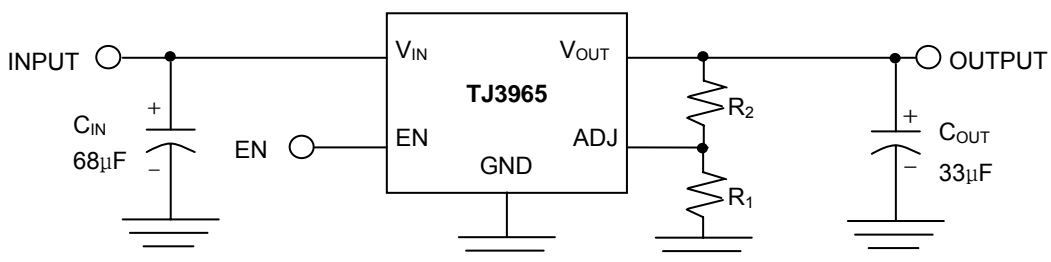

* TJ3965 can deliver a continuous current of 1.5A over the full operating temperature. However, the output current is limited by the restriction of power dissipation which differs from packages. A heat sink may be required depending on the maximum power dissipation and maximum ambient temperature of application. With respect to the applied package, the maximum output current of 1.5A may be still undeliverable.

* When a Pull-Up resistor is connected between V_{EN} terminal and V_{EN} Signal (or V_{IN} line), the resistance of the Pull-Up resistor should be kept under 10k Ω .

* See Application Information

ELECTRICAL CHARACTERISTICS^(Note 1)

Limits in standard typeface are for $T_J=25^\circ\text{C}$, and limits in **boldface type** apply over the **full operating temperature range**.
 Unless otherwise specified: $V_{IN}^{(Note 2)} = V_{O(NOM)} + 1\text{ V}$, $I_L = 10\text{ mA}$, $C_{IN} = 68\text{ }\mu\text{F}$, $C_{OUT} = 33\text{ }\mu\text{F}$, $V_{EN} = V_{IN} - 0.3\text{ V}$

PARAMETER	SYMBOL	TEST CONDITION	MIN.	TYP.	MAX.	UNIT	
Output Voltage Tolerance	V_O	$10\text{ mA} < I_L < 1.5\text{ A}$ $V_{OUT}+1\text{ V} < V_{IN} < 6\text{ V}$	-2 -3	0	2 3	%	
Adjustable Pin Voltage (ADJ version)	V_{ADJ}	$10\text{ mA} < I_L < 1.5\text{ A}$ $V_{OUT}+1.5\text{ V} < V_{IN} < 6\text{ V}$	1.117 1.110	1.145	1.174 1.188	V	
Line Regulation ^(Note 3)	ΔV_{LINE}	$V_{OUT}+1\text{ V} < V_{IN} < 6\text{ V}$	-	0.08	0.18 0.20	%/V	
Load Regulation ^(Note 3, 4)	ΔV_{LOAD}	$10\text{ mA} < I_L < 1.5\text{ A}$	-	0.25	0.55 1.00	%	
Dropout Voltage ^(Note 5)	V_{DROP}	$I_L = 150\text{ mA}$	-	40	55 65	mV	
		$I_L = 1.5\text{ A}$	-	380	450 550		
Ground Pin Current ^(Note 6)	I_{GND1}	$I_L = 150\text{ mA}$	-	30	55 75	uA	
		$I_L = 1.5\text{ A}$	-	30	55 75		
Ground Pin Current ^(Note 7)	I_{GND2}	$V_{EN} < 0.2\text{ V}$	-	30	55 75	uA	
Output Peak Current	I_{PEAK}		2.0 1.7	2.2	-	A	
Thermal Shutdown Temperature	T_{SD}		-	165	-	$^\circ\text{C}$	
Thermal Shutdown Hysteresis	ΔT_{SD}		-	10	-	$^\circ\text{C}$	
Enable threshold	Logic Low	V_{IL}	Output = Low	-	0	$\frac{V_{IN}}{2} - 0.5$	V
	Logic High	V_{IH}	Output = High	$\frac{V_{IN}}{2} + 0.5$	V_{IN}	-	V
Enable Input Current	I_{EN}	$V_{EN} = V_{IN}$	-	0.05	2	uA	

Note 1. Stresses listed as the absolute maximum ratings may cause permanent damage to the device. These are for stress ratings. Functional operating of the device at these or any other conditions beyond those indicated in the operational sections of the specifications is not implied. Exposure to absolute maximum rating conditions for extended periods may remain possibly to affect device reliability.

Note 2. The minimum operating value for input voltage is equal to either $(V_{OUT,NOM} + V_{DROP})$ or 2.5V, whichever is greater.

Note 3. Output voltage line regulation is defined as the change in output voltage from the nominal value due to change in the input line voltage. Output voltage load regulation is defined as the change in output voltage from the nominal value due to change in load current.

Note 4. Regulation is measured at constant junction temperature by using a 20ms current pulse. Devices are tested for load regulation in the load range from 10mA to 1.5A

Note 5. Dropout voltage is defined as the minimum input to output differential voltage at which the output drops 2% below the nominal value. Dropout voltage specification applies only to output voltages of 2.5V and above. For output voltages below 2.5V, the dropout voltage is nothing but the input to output differential, since the minimum input voltage is 2.5V

Note 6. Ground current, or quiescent current, is the difference between input and output currents. It's defined by $I_{GND1} = I_{IN} - I_{OUT}$ under the given loading condition. The total current drawn from the supply is the sum of the load current plus the ground pin current.

Note 7. Ground current, or standby current, is the input current drawn by a regulator when the output voltage is disabled by an enable signal.

TYPICAL OPERATING CHARACTERISTICS

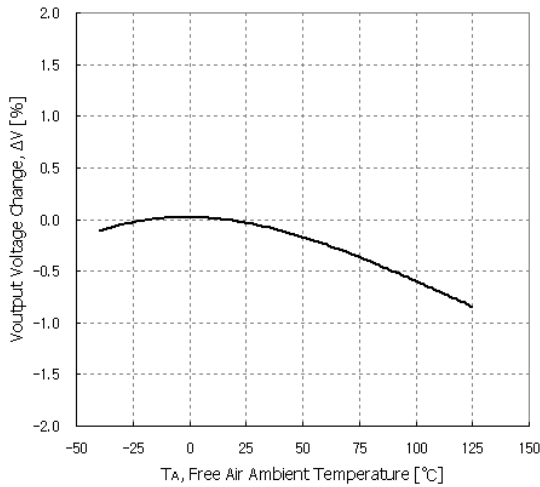

Ambient Temperature vs. Output Voltage Change

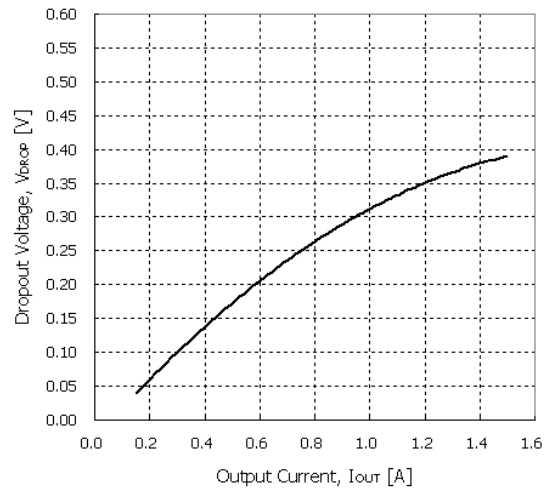

Output Current vs. Dropout Voltage

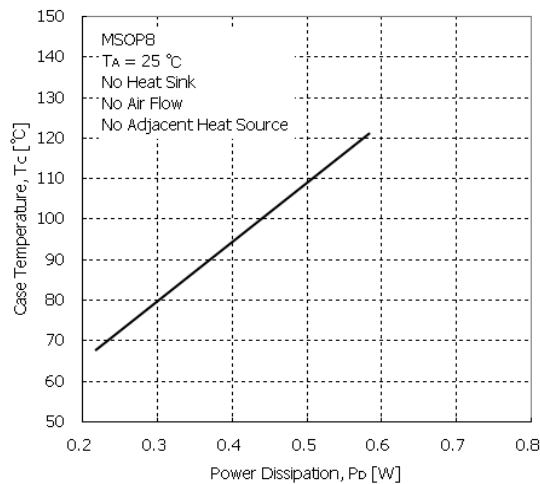

Power Dissipation vs. Case Temperature, MSOP8

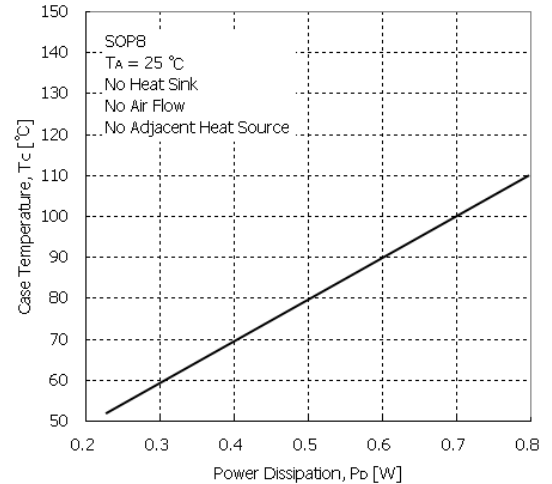

Power Dissipation vs. Case Temperature, SOP8

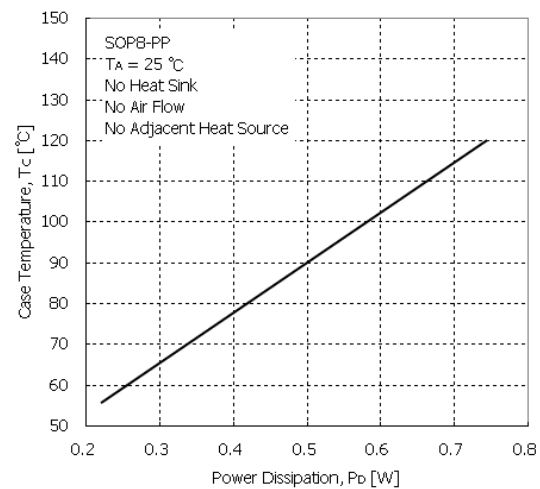

Power Dissipation vs. Case Temperature, SOP8-PP

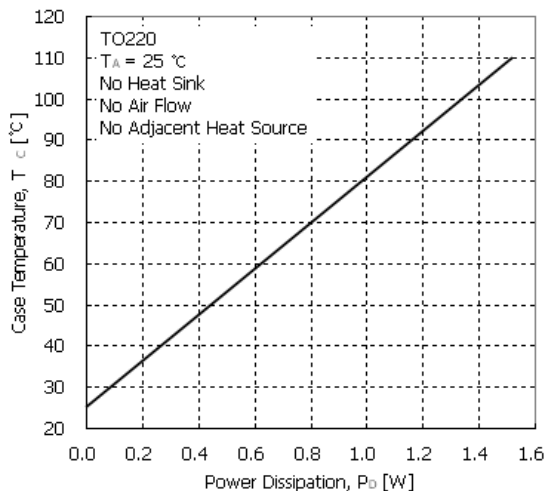

Power Dissipation vs. Case Temperature, TO220

T.B.D.

APPLICATION INFORMATION

Output Adjustment (Adjustable Version)

An adjustable output device has output voltage range of 1.145V to 5.0V. To obtain a desired output voltage, the following equation can be used with R1 resistor. The sum of R1 and R2 should be in range of 1kΩ to 100kΩ

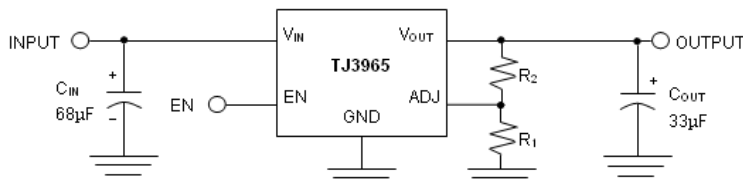

$$R2 = R1 \left(\frac{V_{OUT}}{1.145} - 1 \right)$$

To enhance output stability, a capacitor of 68pF to 100pF can be placed in series with V_{OUT} and ADJ.

SENSE Pin

In applications where the regulator output is not very close to the load, the TJ3965 can provide better remote load regulation characteristics using the SENSE pin. TJ3965 regulates the voltage at the output pin. Hence, the voltage at the remote load will be lower than the voltage at the output pin as a value of the voltage drop across the trace series resistance. If the sense option pin is not required, the sense pin must be connected to the V_{OUT} pin. Connecting the sense pin to the remote load will provide regulation at the remote load because the TJ3965 regulates the voltage at the sense pin when the sense option pin is used.

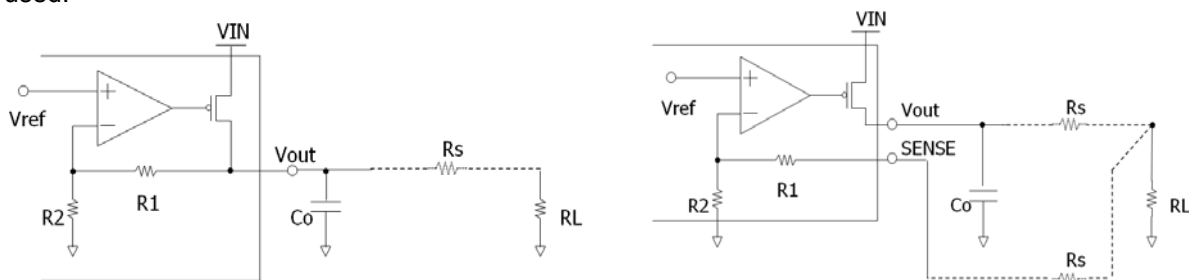

Maximum Output Current Capability

The TJ3965 can deliver a continuous current of 1.5A over the full operating junction temperature range. However, the output current is limited by the restriction of power dissipation which differs from packages. A heat sink may be required depending on the maximum power dissipation and maximum ambient temperature of application. With respect to the applied package, the maximum output current of 1.5A may be still undeliverable due to the restriction of the power dissipation of TJ3965. Under all possible conditions, the junction temperature must be within the range specified under operating conditions.

The temperatures over the device are given by:

$$T_C = T_A + P_D \times \theta_{CA} \quad / \quad T_J = T_C + P_D \times \theta_{JC} \quad / \quad T_J = T_A + P_D \times \theta_{JA}$$

where T_J is the junction temperature, T_C is the case temperature, T_A is the ambient temperature, P_D is the total power dissipation of the device, θ_{CA} is the thermal resistance of case-to-ambient, θ_{JC} is the thermal resistance of junction-to-case, and θ_{JA} is the thermal resistance of junction to ambient.

The total power dissipation of the device is given by:

$$\begin{aligned} P_D &= P_{IN} - P_{OUT} = (V_{IN} \times I_{IN}) - (V_{OUT} \times I_{OUT}) \\ &= (V_{IN} \times (I_{OUT} + I_{GND})) - (V_{OUT} \times I_{OUT}) = (V_{IN} - V_{OUT}) \times I_{OUT} + V_{IN} \times I_{GND} \end{aligned}$$

1.5A Ultra Low Dropout Linear Regulator

TJ3965

where I_{GND} is the operating ground current of the device which is specified at the Electrical Characteristics. The maximum allowable temperature rise (T_{Rmax}) depends on the maximum ambient temperature (T_{Amax}) of the application, and the maximum allowable junction temperature (T_{Jmax}):

$$T_{Rmax} = T_{Jmax} - T_{Amax}$$

The maximum allowable value for junction-to-ambient thermal resistance, θ_{JA} , can be calculated using the formula:

$$\theta_{JA} = T_{Rmax} / P_D = (T_{Jmax} - T_{Amax}) / P_D$$

TJ3965 is available in SOT223, MSOP8, SOP8-PP, TO263, TO220, and SOT89 packages. The thermal resistance depends on amount of copper area or heat sink, and on air flow. If the maximum allowable value of θ_{JA} calculated above is over 140°C/W for SO-223 package, over 220°C/W for MSOP8 package, over 165°C/W for SOP8 package, over 175°C/W for SOP8-PP package, over 105 °C/W for TO252 package, over 80 °C/W for TO263 package, over 70 °C/W for TO220 package, no heat sink is needed since the package can dissipate enough heat to satisfy these requirements. If the value for allowable θ_{JA} falls near or below these limits, a heat sink or proper area of copper plane is required.

In summary, the absolute maximum ratings of thermal resistances are as follow:

Absolute Maximum Ratings of Thermal Resistance

No heat sink / No air flow / No adjacent heat source / $T_A = 25^\circ\text{C}$

Characteristic	Symbol	Rating	Unit
Thermal Resistance Junction-To-Ambient / MSOP8	$\theta_{JA-MSOP8}$	220	°C/W
Thermal Resistance Junction-To-Ambient / SOP8	$\theta_{JA-SOP8}$	165	°C/W
Thermal Resistance Junction-To-Ambient / SOP8-PP	$\theta_{JA-SOP8-PP}$	175	°C/W
Thermal Resistance Junction-To-Ambient / SOT223	$\theta_{JA-SOT223}$	140	°C/W
Thermal Resistance Junction-To-Ambient / TO252	$\theta_{JA-TO252}$	105	°C/W
Thermal Resistance Junction-To-Ambient / TO263	$\theta_{JA-TO263}$	80	°C/W
Thermal Resistance Junction-To-Ambient / TO220	$\theta_{JA-TO220}$	70	°C/W
Thermal Resistance Junction-To-Ambient / SOT89	$\theta_{JA-SOT89}$	200	°C/W

In case that there is no cooling solution and no heat sink / copper plane area for heat sink, the maximum allowable power dissipation of each package is as follow;

Characteristic	Symbol	Rating	Unit
Maximum Allowable Power Dissipation at $T_A=25^\circ\text{C}$ / MSOP8	$P_{DMax-MSOP8}$	0.455	W
Maximum Allowable Power Dissipation at $T_A=25^\circ\text{C}$ / SOP8	$P_{DMax-SOP8}$	0.606	W
Maximum Allowable Power Dissipation at $T_A=25^\circ\text{C}$ / SOP8-PP	$P_{DMax-SOP8-PP}$	0.571	W
Maximum Allowable Power Dissipation at $T_A=25^\circ\text{C}$ / SOT223	$P_{DMax-SOT223}$	0.714	W
Maximum Allowable Power Dissipation at $T_A=25^\circ\text{C}$ / TO252	$P_{DMax-TO252}$	0.952	W
Maximum Allowable Power Dissipation at $T_A=25^\circ\text{C}$ / TO263	$P_{DMax-TO263}$	1.250	W
Maximum Allowable Power Dissipation at $T_A=25^\circ\text{C}$ / TO220	$P_{DMax-TO220}$	1.429	W
Maximum Allowable Power Dissipation at $T_A=25^\circ\text{C}$ / SOT89	$P_{DMax-SOT89}$	0.500	W

- Please note that above maximum allowable power dissipation is based on the minimum copper plane area which does not exceed the proper footprint of the package. And the ambient temperature is 25°C.

If proper cooling solution such as heat sink, copper plane area, air flow is applied, the maximum allowable power dissipation could be increased. However, if the ambient temperature is increased, the allowable power dissipation would be decreased.

For example, in case of SOT223 and TO263 package, $\theta_{JA-SOP8}$ is 140 °C/W and $\theta_{JA-TO263}$ is 80 °C/W, however, as shown in below graph, θ_{JA} could be decreased with respect to the copper plane area. So, the specification of maximum power dissipation for an application is fixed, the proper copper plane area could be estimated by following graphs. As shown in graph, wider copper plane area leads lower θ_{JA} .

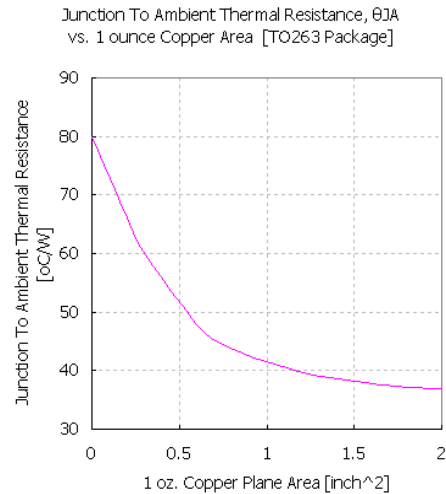
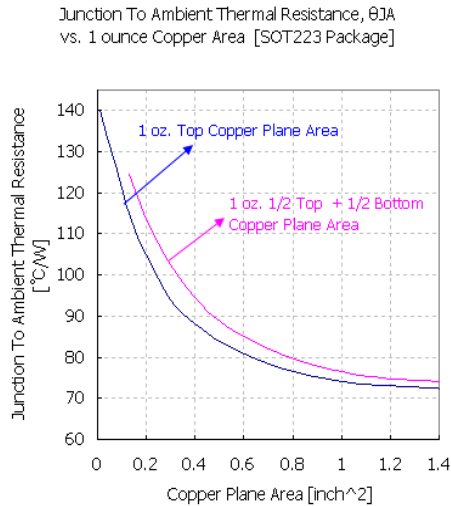

The maximum allowable power dissipation is also influenced by the ambient temperature. With the above θ_{JA} -Copper plane area relationship, the maximum allowable power dissipation could be evaluated with respect to the ambient temperature. As shown in graph, the higher copper plane area leads θ_{JA} . And the higher ambient temperature leads lower maximum allowable power dissipation.

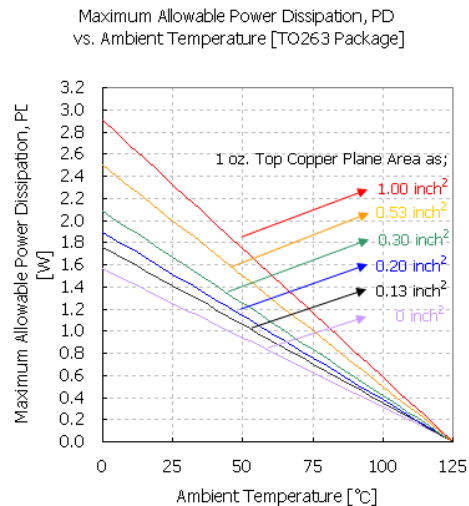
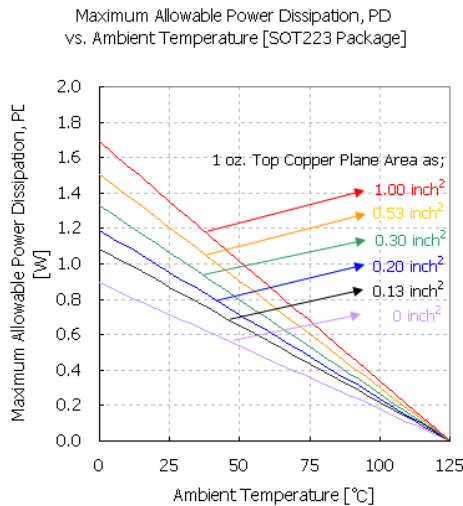

All this relationship is based on the aforesaid equation ; $\theta_{JA} = T_{Rmax} / P_D = (T_{Jmax} - T_{Amax}) / P_D$

T.B.D