

**SCHEMATIC**

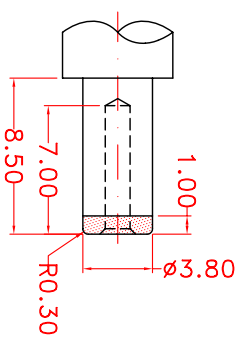

**MATE PLUG**

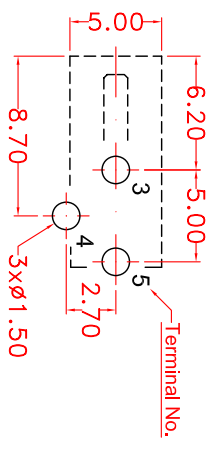

**PIERCING PLAN**

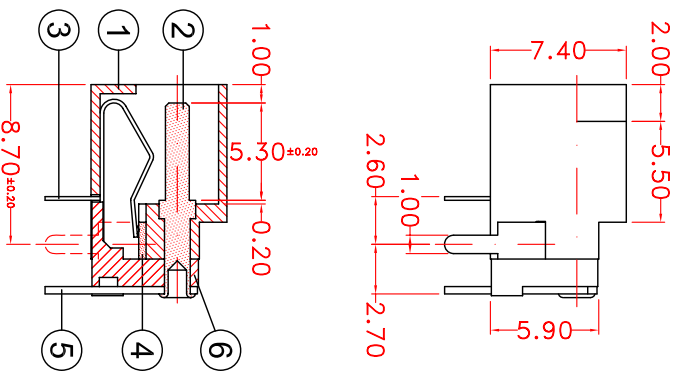
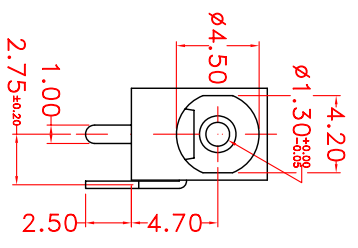

6	COVER BOARD	1	PA66+G.F.	BLACK COLOR
5	PIN TERMINAL	1	BRASS	Ag PLATED
4	SLEEVE BREAK	1	BRASS	Ag PLATED
3	SLEEVE SPRING	1	SPRING ALLOY	Ag PLATED
2	PIN SHAFT	1	BRASS	Ni PLATED
1	HOUSING	1	POLYCARBONATE (PC)	BLACK COLOR
No.	PARTS	QTY.	MATERIAL	TREATMENT



**THE 3rd ANGLE PROJECTION**

ALL DIMENSIONS TOLERANCE ARE IN ABOVE, UNLESS OTHERWISE SPECIFIED.

SCALE : 3:2:1.0	DESIGN BY : So Chung Choi	26-NOV-2004	DESCRIPTION : H=4.70mm PCB DC POWER JACK
UNIT : MILLIMETER (mm)	DRAWN BY : So Chung Choi	15-SEP-2011	MODEL NO. : DC-020-002-00-CN
TOLERANCE : ±0.20	CHECKED BY :		CAD FILE : C:\JACK DRAWING\DC020000200-CN
ANGLE TOL. : 2° 30'	APPROVED BY :		DRAWING FILE : D2K11098

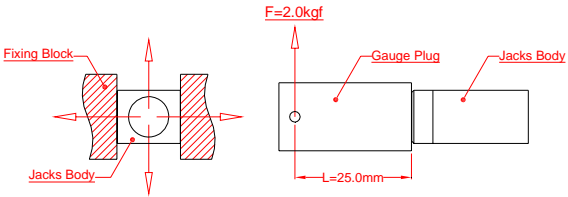

1. General (一般規格)			
1-1	Scope 範圍	This specification covers <b>Sun Rise</b> standard small size DC power jacks. 此規格書適用於日高標準小型直流插座。	
1-2	Type of Mounting 裝置類型	H=4.70mm Horizontal Through Hole PCB Mount. 柱芯中心高=4.70 毫米水平穿孔線路板裝置。	
1-3	Pin Shaft Diameter 柱芯直徑	Ø1.30mm 直徑 1.30 毫米	
1-4	Gauge Plug 測試插頭	The gauge plug should be as shown in Fig.1 or equivalent. 測試插頭必須如圖 1 或相等。	
1-5	Measurement Condition 測試條件	All measurement should be done at room ambient temperature and relative humidity 45%-85%. 所有測試皆在正常溫度及相對濕度 45-85%進行。	
1-6	Packing 包裝	Bulk Pack 散袋包裝	
2. Mechanical (機械特性)			
No.	Item 項目	Test conditions 測試條件	Performance 結果
2-1	Insertion Force 插入力	Insertion and withdrawal force shall be measured after inserting and withdrawing 3 times by using the standard dimension gauge plug. 插入力或拔出力必須使用標準尺寸之測試插咀，並經 3 周次插拔後方可量度。	0.5kgf~3.0kgf
2-2	Withdrawal Force 拔出力		
2-3	Terminal Strength 端子強度	A static load of 0.5kgf shall be applied to the tip of the terminals for 1 min in any direction. 0.5kgf 靜負荷，施加于端子頂端的任何方向持續 1 分鐘。	Neither damage caused by crack nor omission of terminals shall be existent. However, warps and bends, which do not affect mechanical and electrical characteristics, will be considered acceptable. 端子沒有擊穿和損壞，只有不影響機械和電氣特性的變型和彎曲，則為可容許接受。
3. Electrical (電氣特性)			
3-1	Rating 額定值		DC12V@0.5A
3-2	Contact Resistance 接觸阻抗	Measurement shall be made at 1kHz with micro current (100mA or less). Using a gold plated probe shall make measurement between the contact spring and the gold plated plug. 測試須於 1kHz 微電流及(100mA 或以下)電壓下進行，並使用鍍金探針於接觸彈片與鍍金插頭之間測量。	30m Ω or less (Initial) 30 毫歐或以下 (最初值)
3-3	Insulation Resistance 絕緣阻抗	Measurement shall be applied voltage of DC 500V, and make measurement between terminals and insulated mate plug for 1 minute. (Mate Plug Fig.1) 測試須於接上 DC500V 電壓下進行，量度端子與絕緣插頭間，持續 1 分鐘測量。(絕緣插頭如圖 1)	100M Ω or more (Initial) 100 兆歐或以上 (最初值)
3-4	Dielectric Strength 耐電壓	Measurement shall be applied voltage of AC 500V (50~60Hz) and make measurement between terminals and insulated mate plug for 1 minute. (Mate Plug Fig.1) 測試須於接上 AC 500V (50~60Hz)電壓下進行，量度端子與絕緣插頭間，持續 1 分鐘測量。(絕緣插頭如圖 1)	There shall be no burn caused by short circuit and insulation destruction. 沒有因短路或絕緣損壞而引起燒。

4. Durability (耐久性)			
4-1	Solder-ability 可焊性	The terminal shall be immersed in the solder bath at a temperature of $235^{\circ}\text{C} \pm 5^{\circ}\text{C}$ for $2 \pm 0.5\text{sec}$ . Immersion depth: Up to 2mm from the terminal tip. 端子浸入 $235^{\circ}\text{C} \pm 5^{\circ}\text{C}$ 溶錫槽 $2 \pm 0.5$ 秒 浸入深度：離端子頂端 2 毫米。	A new uniform coating of solder shall be cover a minimum of 85% of the surface being immerse 全新錫層覆蓋 85%以上於端子表面。
4-2	Cold Test 耐寒性測試	The jack shall be left at temperature of $-40^{\circ}\text{C} \pm 3^{\circ}\text{C}$ for 96 hours. And then it shall be kept under standard atmospheric condition for 1 hour after which measurement shall be made. 於 $-40^{\circ}\text{C} \pm 3^{\circ}\text{C}$ 的環境中放置 96 小時，然後取出放置於正常環境中 1 小時後進行測試。	The following items shall be satisfied: 2-1, 3-3, 3-4.  Withdrawal force: 0.3kgf~3.0kgf  Contact resistance: 50m $\Omega$ or less
4-3	Heat Test 耐熱性測試	The jack shall be left at a temperature of $85^{\circ}\text{C} \pm 2^{\circ}\text{C}$ for 96 hours. And then it shall be kept under standard atmospheric condition for 1 hour after which measurement shall be made. 於 $85^{\circ}\text{C} \pm 2^{\circ}\text{C}$ 的環境中放置 96 小時，然後取出放置於正常環境中放置 1 小時後進行測試。	符合下列項目: 2-1, 3-3, 3-4.  拔出力量: 0.3kgf~3.0kgf  接觸抵抗: 50 毫歐以下
4-4	Humidity Test 耐濕性測試	The jack shall be left at a temperature of $40^{\circ}\text{C} \pm 2^{\circ}\text{C}$ relative humidity of 90% to 95% for 96 hours. And then it shall be kept under standard atmospheric conditions for 1 hour after which measurement shall be made. 於 $40^{\circ}\text{C} \pm 2^{\circ}\text{C}$ 及相對濕度 90~95%的環境中放置 96 小時，然後取出放置於正常環境中 1 小時後進行測試。	
4-5	Life Test Condition 壽命測試條件	Life test shall be done at (15~18 cycles / minute) <u>Unloaded</u> . Before the test, apply contact grease to the sliding surface of the gauge plug in order to prevent the part from over-heating and wearing due to friction. 壽命測試於沒有負載下完成，每分鐘 15~18 周次。 為了防止過熱和磨損，在測試前需加上潤滑油在測試插頭表面。	The following items shall be satisfied: 3-3, 3-4  Insertion force: 0.3kgf~3.0kgf  Withdrawal force: 0.3kgf~3.0kgf
4-6	Life of Jacks 插座的壽命	After 5,000 cycles of continuous insertion and withdrawal. 5,000 周次連續插入及拔出。	Contact resistance: 50m $\Omega$ or less  符合下列項目: 3-3, 3-4.  插入力量: 0.3kgf~3.0kgf  拔出力量: 0.3kgf~3.0kgf  接觸抵抗: 50 毫歐以下
4-7	Bending Strength 彎曲強度	The housing of jack shall be fixed after which the standard dimension gauge shall be inserted. And then a load with torque of approx. 2.0kgf shall be applied to horizontal and vertical directions to the jack for 5 cycles in 5 sec. each. 固定插座後，插入標準尺寸插頭，施加約 2.0kgf 拉力負荷于插座的任何方向 5 次持續 5 秒。  	The following items shall be satisfied: 2-1, 3-3, 3-4.  Withdrawal force: 0.3kgf~3.0kgf  Contact resistance: 50m $\Omega$ or less  符合下列項目: 2-1, 3-3, 3-4.  拔出力量: 0.3kgf~3.0kgf  接觸抵抗: 50 毫歐以下

## 5. Test conditions (測試條件)

### 5-1 Applicable mate plug and gauge plug Fig.1 適用插頭及測試插頭

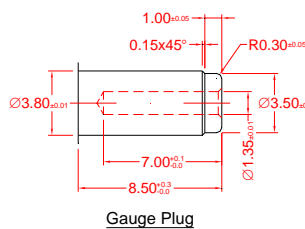

**Note:**

1. Roughness of the surface : 0.8s
2. Material : Standard dimension gauge  
Stainless steel (SUS) or alloy tool steel (SKS2)  
Insulated gauge  
Teflon (PETE) or Delrin (POM)

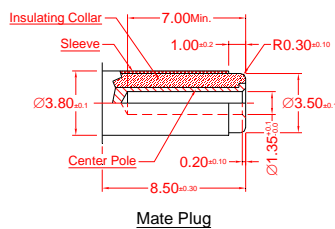

**Note:**

1. [Hatched pattern] : Matt. part are insulation collar.
2. [Dotted pattern] : Net part are sleeve contact.
3. [Diagonal lines] : Section part are center pole contact.

## 6. Precautions in Handling (處理過程中的預防)

### 6-1 Operating temperature and humidity range (應用溫度和濕度範圍)

Temperature: -25°C~70°C / Humidity: 70% R.H. or less.  
溫度 -25°C~70°C / 相對濕度 70% R.H. 或以下

### 6-2 Recommended to **Wave Soldering** conditions 建議波峰焊條件

Solder temperature: 260°C ± 5°C  
熔錫焊料溫度: 260°C ± 5°C

Operating time: 5 ± 0.5 second  
操作時間: 5 ± 0.5 秒

PCB thickness: 1.00mm or more  
線路基板厚度: 1.00 毫米或以上

### 6-3 For manual soldering conditions (by solder iron) 手焊條件(烙鐵)

Solder iron bit temperature: 350°C ± 5°C  
烙鐵咀溫度: 350°C ± 5°C

Operating time: 3 ± 0.5 second  
操作時間: 3 ± 0.5 秒

Load on terminal: approx. 50gf or less  
端子負荷: 約 50gf 或以下

### 6-4 Storage (貯存方法)

This jack is silver-plated. Therefore, this jack should not be left with the package open, In case plating sulfurous soldering trouble or contact trouble will happen. The shelf life remains 6 months under the formal condition.  
此插座為鍍銀產品，因此這插座不能外露於包裝外，以防氧化問題或接觸不良發生。保質期於正常條件下可保持 6 個月。

### 6-5 Washing (清洗方法)

This jack shall not be washed. In case this jack is washed contact trouble will happen.  
此插座不能作清洗處理。若清洗插座會發生接觸不良問題。

### 6-6 Other necessary item (其他項目)

Please consult with **Sun Rise** before using the unit or performing tests under conditions other than those listed in these specifications.  
在使用此產品或執行以上說明內列舉的條件測試前，請與日高電子零件有限公司聯絡。

\*\*\*\* END \*\*\*\*